

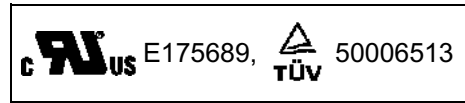

RADIAL LEADED PTC RB MODEL



■ FEATURES

- Radial Leaded, high hold current, solid state
- Operation current: 900mA~9A
- Maximum Voltage: 30V
- Temperature range: -40°C to 85°C
- Cured, flame retardant epoxy polymer insulating material meets UL 94V-0 requirement
- Bulk packaging, tape and reel available on most models

■ APPLICATIONS

- ◆ Ideal for low voltage power supply with a load to be protected:
 - Computers & peripherals
 - Security and fire alarm system
 - General electronics
 - Loud speakers
 - Automotive applications
 - Power transformers

■ PART NUMBERING SYSTEM

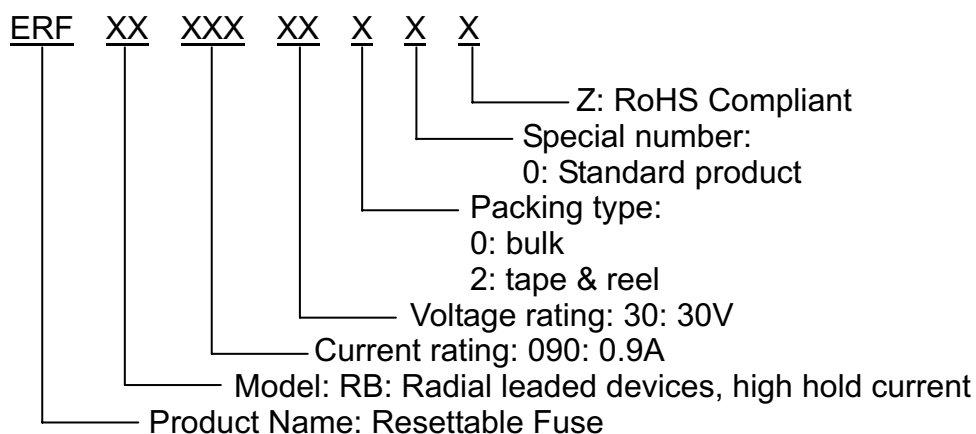

■ Marking system

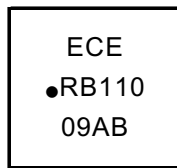

Example

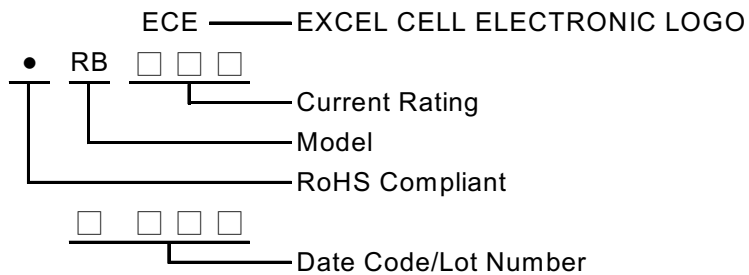

■ Electrical characteristics(23°C)

Part Number	Hold Current	Trip Current	Max. Time to trip	Maximum Current	Rated Voltage	Typical Power	Resistance Tolerance	
							R _{MIN}	R _{1MAX}
	I _H , A	I _T , A	at 5xI _H	I _{MAX} , A	V _{MAX} , V _{dc}	P _d , W	Ω	Ω
RB090-30	0.90	1.80	5.9	40	30	0.6	0.070	0.22
RB110-30	1.10	2.20	6.6	40	30	0.7	0.050	0.17
RB135-30	1.35	2.70	7.3	40	30	0.8	0.040	0.13
RB160-30	1.60	3.20	8.0	40	30	0.9	0.030	0.11
RB185-30	1.85	3.70	8.7	40	30	1.0	0.030	0.09
RB250-30	2.50	5.00	10.3	40	30	1.2	0.020	0.07
RB300-30	3.00	6.00	10.8	40	30	2.0	0.020	0.08
RB400-30	4.00	8.00	12.7	40	30	2.5	0.010	0.05
RB500-30	5.00	10.00	14.5	40	30	3.0	0.010	0.05
RB600-30	6.00	12.00	16.0	40	30	3.5	0.005	0.04
RB700-30	7.00	14.00	17.5	40	30	3.8	0.005	0.03
RB800-30	8.00	16.00	18.8	40	30	4.0	0.005	0.02
RB900-30	9.00	18.00	20.0	40	30	4.2	0.005	0.02

I_H=Hold current-maximum current at which the device will not trip at 23°C still air.

I_T=Trip current-minimum current at which the device will always trip at 23°C still air.

V_{MAX}=Maximum voltage device can withstand without damage at rated current.

I_{MAX}= Maximum fault current device can withstand without damage at rated voltage (V max).

P_d=Typical power dissipated from device when in the tripped state in 23°C still air environment.

R_{MIN}=Minimum device resistance at 23°C .

R_{1MAX}=Maximum device resistance at 23°C 1 hour after tripping .

■ Typical time-to-trip-at 23°C

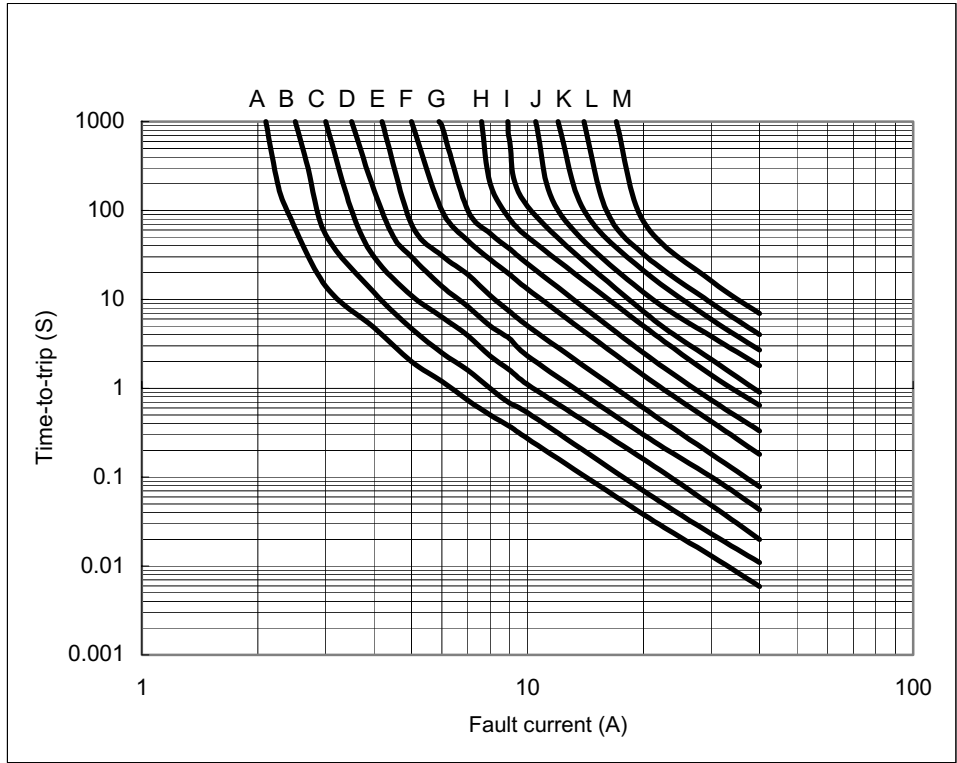

- A=RB090-30
- B=RB110-30
- C=RB135-30
- D=RB160-30
- E=RB185-30
- F=RB250-30
- G=RB300-30
- H=RB400-30
- I=RB500-30
- J=RB600-30
- K=RB700-30
- L=RB800-30
- M=RB900-30

■ Thermal Derating Curve

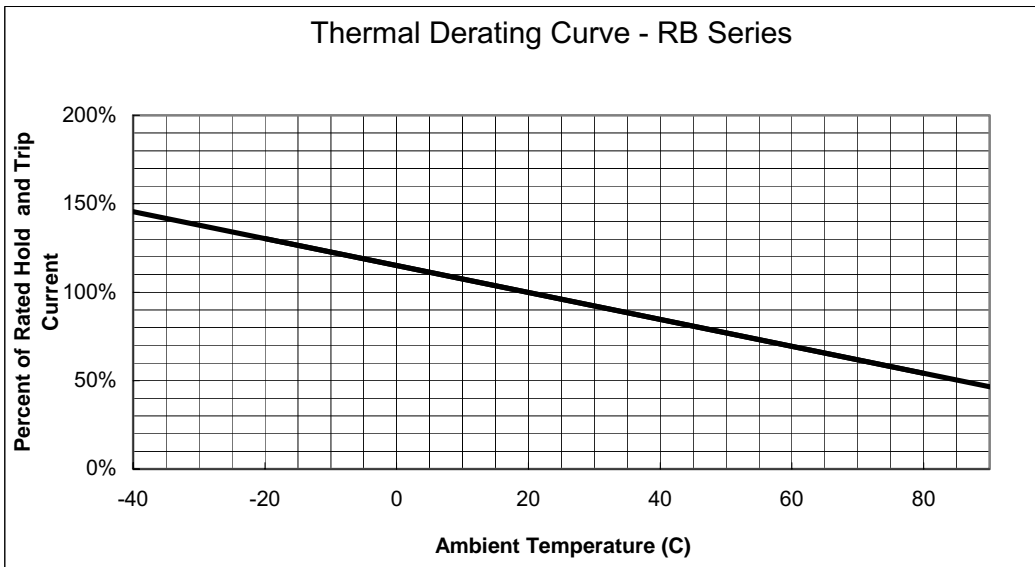

■ **RB Product Dimensions (UNIT: mm)**

Part Number	A	B	C	D	E	F
	Maximum	Maximum	Typical	Minimum	Maximum	Typical
RB090-30	7.4	12.2	5.1	7.6	3.0	0.9
RB110-30	7.4	14.2	5.1	7.6	3.0	0.9
RB135-30	8.9	13.5	5.1	7.6	3.0	0.9
RB160-30	8.9	15.2	5.1	7.6	3.0	0.9
RB185-30	10.2	15.7	5.1	7.6	3.0	0.9
RB250-30	11.4	18.3	5.1	7.6	3.0	0.9
RB300-30	11.4	17.3	5.1	7.6	3.0	1.2
RB400-30	14.0	20.1	5.1	7.6	3.0	1.2
RB500-30	14.0	24.9	10.2	7.6	3.0	1.2
RB600-30	16.5	24.9	10.2	7.6	3.0	1.2
RB700-30	19.1	26.7	10.2	7.6	3.0	1.2
RB800-30	21.6	29.2	10.2	7.6	3.0	1.2
RB900-30	24.1	29.7	10.2	7.6	3.0	1.2

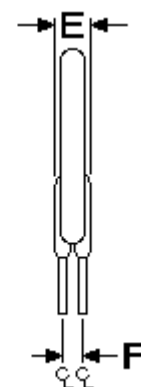
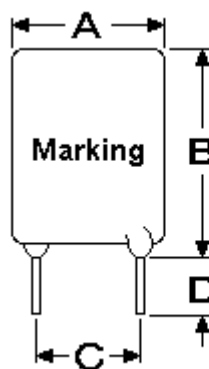
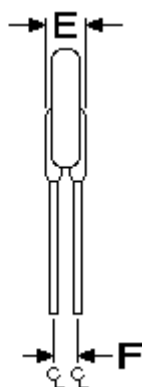
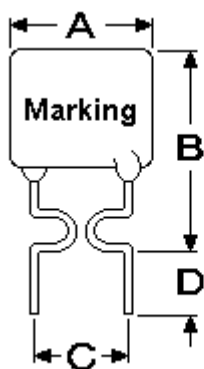

RB 090-30 ~ RB 250-30

- Lead Size: 24AWG
- φ0.51mm Diameter

RB 300-30 ~ RB 900-30

- Lead Size: 20AWG
- φ0.81mm Diameter

■ **Standard Package for Reference**

P/N	Pcs/Bag	Reel/Tape	P/N	Pcs/Bag	Reel/Tape
RB090-30	500	3K	RB400-30	200	1.5K
RB110-30	500	3K	RB500-30	200	-----
RB135-30	300	3K	RB600-30	100	-----
RB160-30	300	3K	RB700-30	100	-----
RB185-30	300	3K	RB800-30	100	-----
RB250-30	300	3K	RB900-30	100	-----
RB300-30	200	1.5K			