

SPECIFICATIONS

CONTACT RESISTANCE: 30mΩ max
 INSULATION RESISTANCE: DC 500V 100MΩ min
 DIELECTRIC STRENGTH: AC 1000V 1 minute
 ELECTRICAL LIFE: 30,000 cycles min
 MECHANICAL LIFE: 50,000 cycles min
 TERMINAL MATERIAL: Copper alloy,
 silver or gold plated

BUTTON COLOR CHART:

COLOR NO.	COLOR	COLOR NO.	COLOR
1	White	5	Yellow
2	Black	6	Green
3	Red (Std.)	7	Blue

*RoHS Compliant: Please add a code "H" to part number. □
 For example: R18-25A-3-H

INDEX

TOGGLE

ROCKER

SLIDE

PUSHBUTTON

DIP

TACT

3A 125V AC



Model No.	TYPE
R18-21A	OFF-ON
R18-21B	OFF-(ON)
R18-21C	ON-(OFF)

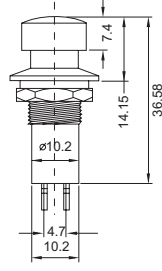
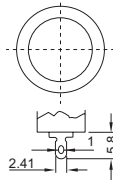

3A 125V AC



Model No.	TYPE
R18-23A	OFF-ON
R18-23B	OFF-(ON)
R18-23C	ON-(OFF)

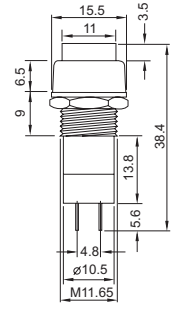
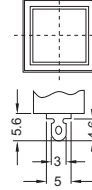

3A 125V AC



Model No.	TYPE
R18-24A	OFF-ON
R18-24B	OFF-(ON)

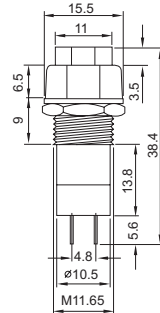
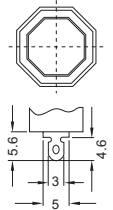

3A 125V AC



Model No.	TYPE
R18-25A	OFF-ON
R18-25B	OFF-(ON)
R18-25C	ON-(OFF)

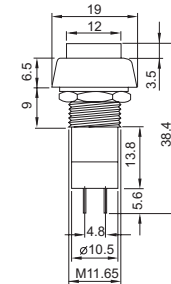
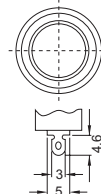

3A 125V AC



Model No.	TYPE
R18-26A	OFF-ON
R18-26B	OFF-(ON)

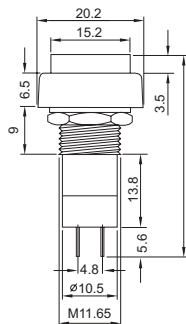
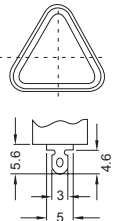

1A 125V AC



Model No.	TYPE
R18-27A	OFF-(ON)
R18-27B	ON-(OFF)

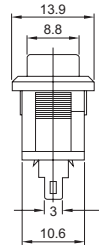
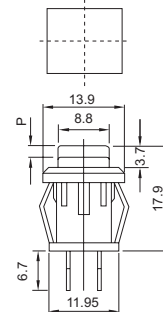

1A 125V AC



Model No.	TYPE
R18-28A	OFF-(ON)

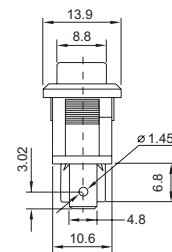
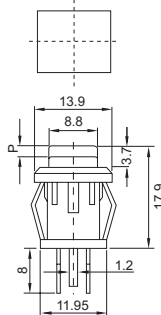

1A 125V AC



Model No.	TYPE
R18-27C	ON-(OFF)

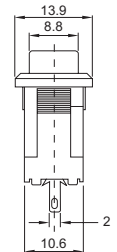
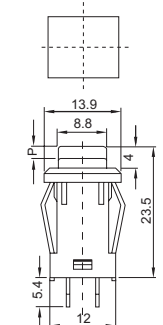

1A 125V AC



Model No.	TYPE
R18-29A	OFF-(ON)
R18-29C	ON-(OFF)

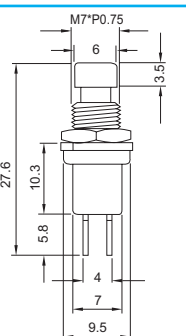
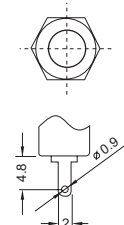

1A 125V AC



Model No.	TYPE
R18-29B	ON-(OFF)

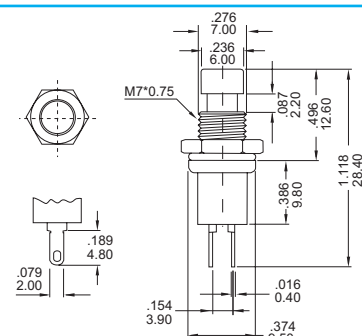



R18

Pushbutton Switches



SPECIFICATIONS

CONTACT RESISTANCE:	DC 5V 1A 30mΩ max
INSULATION RESISTANCE:	DC 500V 100Ω min
DIELECTRIC STRENGTH:	AC 500V 1 minute
ELECTRICAL LIFE:	30,000 cycles
MECHANICAL LIFE:	50,000 cycles
OPERATION FORCE:	500 ± 150g

*RoHS Compliant: Please add a code "H" to part number. For example: S18-23A-H

S18-21



Model No.	TYPE
S18-21A	OFF-ON
S18-21B	OFF-(ON)

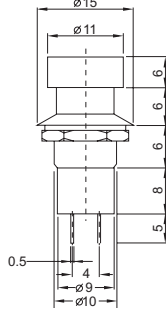
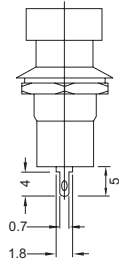

3A 125V AC

S18-23



Model No.	TYPE
S18-23A	OFF-ON
S18-23B	OFF-(ON)

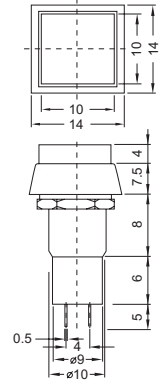
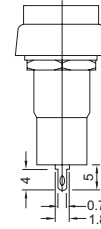

3A 125V AC

S18-25



Model No.	TYPE
S18-25A	OFF-ON
S18-25B	OFF-(ON)

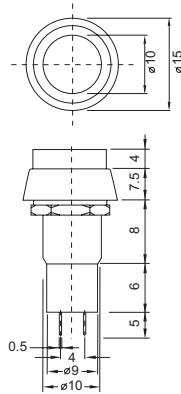
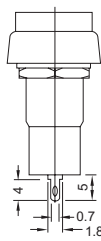

3A 125V AC

R18-36A

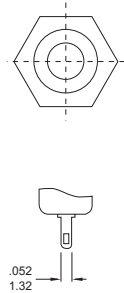
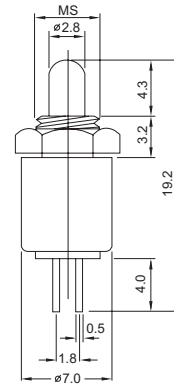

0.5A 125V AC

INDEX

TOGGLE

ROCKER

SLIDE

PUSHBUTTON

DIP

TACT