

PD6NG-XXXXZ2:1 1KV ISOLATED 1W REGULATED DUAL OUTPUT SIP8

Electrical Specifications

(Typical at + 25°C , nominal input voltage, rated output current unless otherwise specified)

Input Specifications

Voltage range 4.5-9, 9-18, 18-36 and 36-72 VDC Wide Input
 Filter Capacitor type

Isolation Specifications

Rated voltage 1000 VDC
 Resistance >1 GΩ
 Capacitance 70 PF

Output Specifications

Voltage accuracy +/- 2 % , typ.
 Ripple and noise (at 20 MHz BW) 100 mV p-p, max.
 Short circuit protection Continuous, auto restart
 Line voltage regulation +/- 0.2 % typ.
 Load voltage regulation +/- 0.5 % typ. load = 10 ~ 100%
 Temperature coefficient +/- 0.02 % / °C

General Specifications

Efficiency Continuous, auto restart
 Switching frequency 75 KHz, typ.

Environmental Specifications

Operating temperature (ambient) - 40 °C to + 80 °C
 Storage temperature - 55 °C to + 125 °C
 Humidity Up to 90 % , non condensing
 Cooling Free air convection

Physical Characteristics

Dimensions SIP 21.80 x 9.20 x 11.10 mm
 Case material Non conductive black plastic

Samples of Partnumbers

PART NO.	INPUT VOLTAGE (VDC)	INPUT CURRENT NO LOAD (mA)	INPUT CURRENT FULL LOAD (mA)	OUTPUT VOLTAGE (VDC)	OUTPUT CURRENT (max.mA)	EFFICIENCY FULL LOAD (% TYP.)
PD6NG-053R3Z2:1	4.5 - 9	24	243	+/- 3.3	± 152	68
PD6NG-0505Z2:1	4.5 - 9	23	236	+/- 5	± 100	70
PD6NG-0509Z2:1	4.5 - 9	23	232	+/- 9	± 55	71
PD6NG-0512Z2:1	4.5 - 9	23	229	+/- 12	± 42	72
PD6NG-0515Z2:1	4.5 - 9	23	229	+/- 15	± 33	72
PD6NG-0524Z2:1	4.5 - 9	23	229	+/- 24	± 21	72
PD6NG-123R3Z2:1	9 - 18	24	236	+/- 3.3	± 152	70
PD6NG-1205Z2:1	9 - 18	12	113	+/- 5	± 100	73
PD6NG-1209Z2:1	9 - 18	12	111	+/- 9	± 55	74
PD6NG-1212Z2:1	9 - 18	11	110	+/- 12	± 42	75
PD6NG-1215Z2:1	9 - 18	11	110	+/- 15	± 33	76
PD6NG-1224Z2:1	9 - 18	12	111	+/- 24	± 21	75
PD6NG-243R3Z2:1	18 - 36	7	58	+/- 3.3	± 152	71
PD6NG-2405Z2:1	18 - 36	7	57	+/- 5	± 100	72
PD6NG-2409Z2:1	18 - 36	7	56	+/- 9	± 55	74
PD6NG-2412Z2:1	18 - 36	7	55	+/- 12	± 42	75
PD6NG-2415Z2:1	18 - 36	7	55	+/- 15	± 33	75
PD6NG-2424Z2:1	18 - 36	7	56	+/- 24	± 21	73
PD6NG-483R3Z2:1	36 - 72	3	29	+/- 3.3	± 152	72
PD6NG-4805Z2:1	36 - 72	4	28	+/- 5	± 100	73
PD6NG-4809Z2:1	36 - 72	4	28	+/- 9	± 55	74
PD6NG-4812Z2:1	36 - 72	4	27	+/- 12	± 42	76
PD6NG-4815Z2:1	36 - 72	4	27	+/- 15	± 33	76
PD6NG-4824Z2:1	36 - 72	4	28	+/- 24	± 21	75

Dimensions

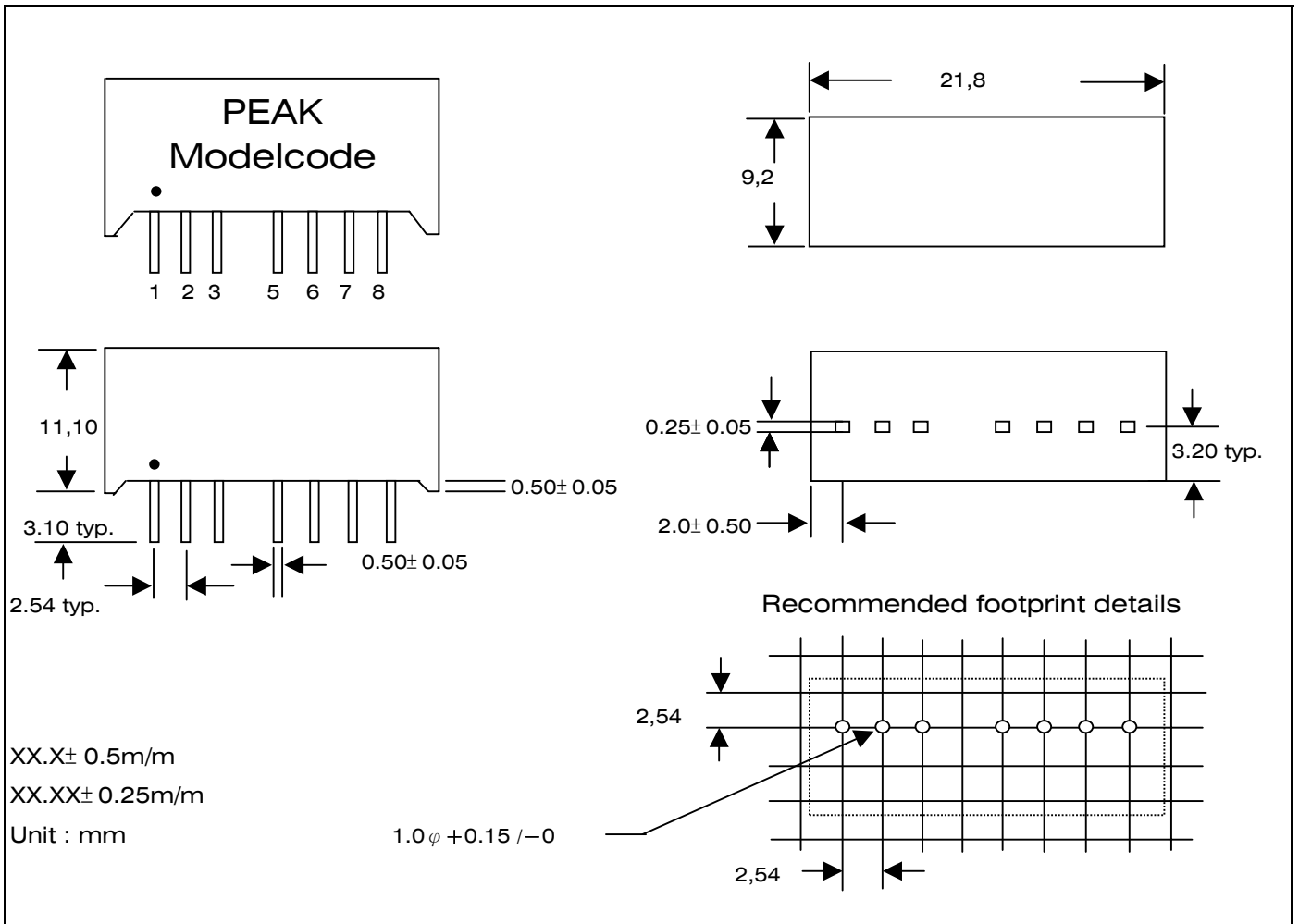

Derating Graph and Pinning

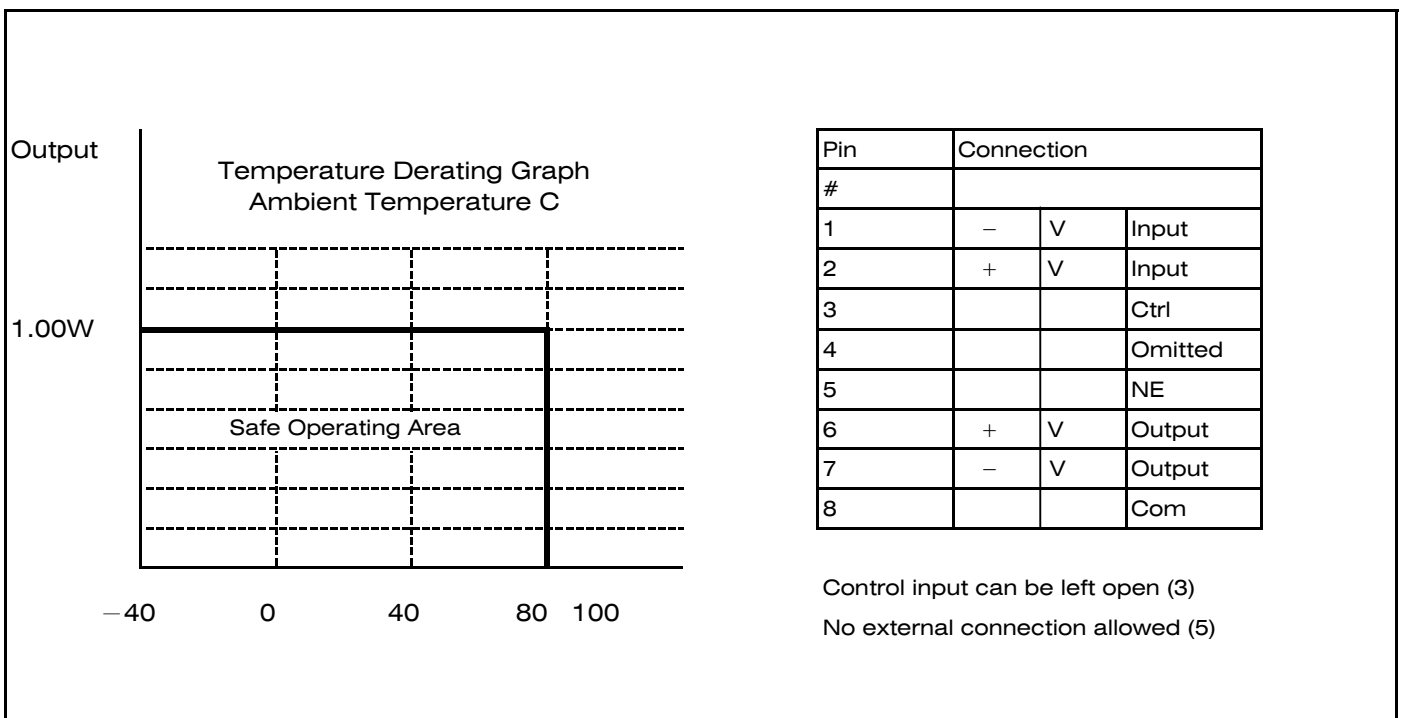

PD6NG-XXXXZ2:1 1KV ISOLATED 1W REGULATED DUAL OUTPUT SIP8

External capacitance:

These converters will work with without external capacitors but they are necessary in order to guarantee the full line load range. All parts have been tested using the following recommended values.

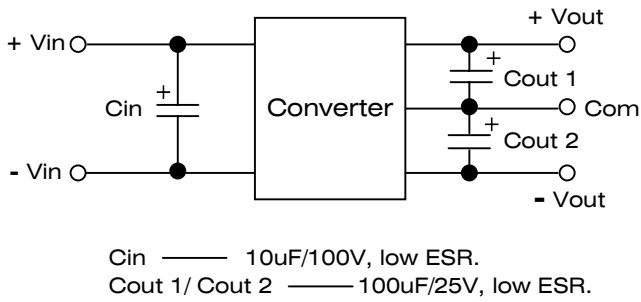

Pin 3 (CTRL)

Control pin (ON/OFF)
Output starts at low or open and stops when high.
Voltage applied via a limiting resistor and switching diode. The converter is in a low power mode during the high level phase.

Connection example

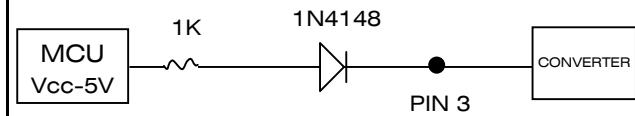

Pin 5 (NE)

This pin is used internally and must have have no external connection.

Application Notes

Pin 3: The outside control connection. This pin provides the converter output ON/OFF, and the control common is referred to negative input.

Pin 5: This pin belongs to the secondary side. It just avoids someone to reverses the primary and secondary.

Specification can be changed without notice.

Copyright PEAK electronics GmbH

REV: 1 / 03.2003