



# DC COMPONENTS CO., LTD.

RECTIFIER SPECIALISTS

KBPC / MB  
25005 / 2505  
THRU  
KBPC / MB  
2510 / 2510

## TECHNICAL SPECIFICATIONS OF SINGLE-PHASE SILICON BRIDGE RECTIFIER

VOLTAGE RANGE - 50 to 1000 Volts

CURRENT - 25 Amperes

### FEATURES

- \* Metal case for Maximum Heat Dissipation
- \* Surge overload ratings-400 Amperes
- \* Low forward voltage drop

### MECHANICAL DATA

- \* Case: Metal, electrically isolated
- \* Epoxy: UL 94V-0 rate flame retardant
- \* Terminals: Plated .25"(6.35mm) Faston lugs, solderable per MIL-STD-202E, Method 208 guaranteed
- \* Polarity: As marked
- \* Mounting position: Any
- \* Weight: 30 grams

### MAXIMUM RATINGS AND ELECTRICAL CHARACTERISTICS

Ratings at 25 °C ambient temperature unless otherwise specified.  
Single phase, half wave, 60 Hz, resistive or inductive load.  
For capacitive load, derate current by 20%.



MB-25

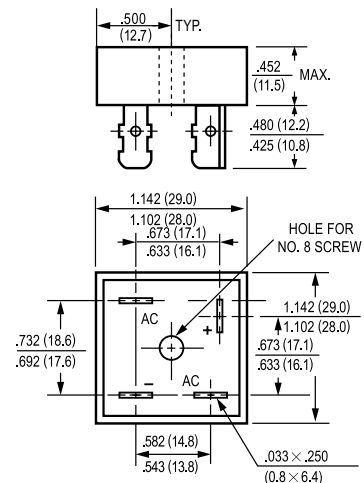

Dimensions in inches and (millimeters)

	SYMBOL	KBPC 25005	KBPC 2501	KBPC 2502	KBPC 2504	KBPC 2506	KBPC 2508	KBPC 2510	UNITS	
Maximum Recurrent Peak Reverse Voltage	V <sub>RRM</sub>	50	100	200	400	600	800	1000	Volts	
Maximum RMS Bridge Input Voltage	V <sub>RMS</sub>	35	70	140	280	420	560	700	Volts	
Maximum DC Blocking Voltage	V <sub>DC</sub>	50	100	200	400	600	800	1000	Volts	
Maximum Average Forward Rectified Output Current at T <sub>c</sub> = 55°C	I <sub>O</sub>					25				Amps
Peak Forward Surge Current 8.3 ms single half sine-wave superimposed on rated load (JEDEC Method)	I <sub>FSM</sub>					400				Amps
Maximum Forward Voltage Drop per element at 12.5A DC	V <sub>F</sub>					1.1				Volts
Maximum DC Reverse Current at Rated	I <sub>R</sub>					10				uAmps
DC Blocking Voltage per element						500				
I <sup>2</sup> t Rating for Fusing (t<8.3ms)	I <sup>2</sup> t					374				A <sup>2</sup> Sec
Typical Junction Capacitance ( Note1)	C <sub>J</sub>					300				pF
Typical Thermal Resistance (Note 2)	R <sub>θJC</sub>					2.5				°C/W
Operating and Storage Temperature Range	T <sub>J</sub> , T <sub>STG</sub>					-55 to + 150				°C

NOTES : 1. Measured at 1 MHz and applied reverse voltage of 4.0 volts  
2. Thermal Resistance from Junction to Case per leg.

RATING AND CHARACTERISTIC CURVES ( KBPC25005 MB2505 THRU KBPC2510 MB2510 )

FIG. 1 - MAXIMUM NON-REPETITIVE FORWARD SURGE CURRENT

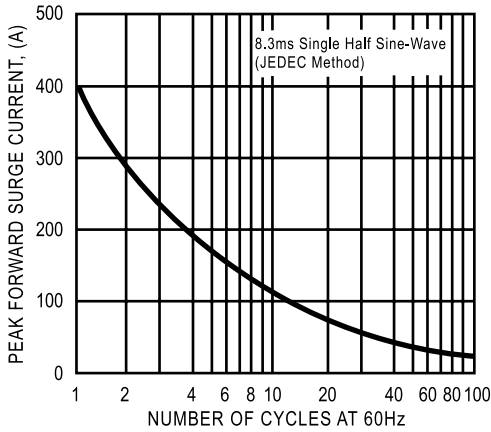

FIG. 2 - TYPICAL FORWARD CURRENT DERATING CURVE

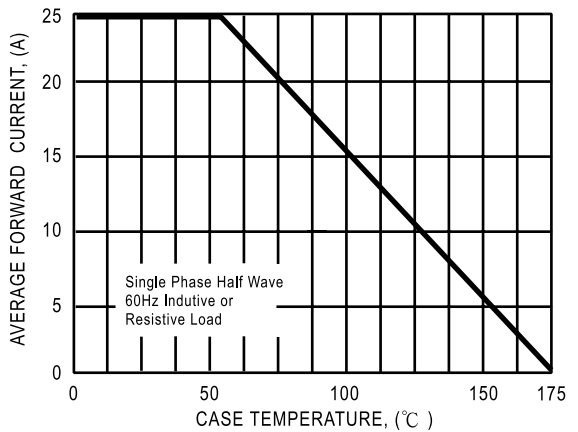

FIG. 3 - TYPICAL INSTANTANEOUS FORWARD CHARACTERISTICS

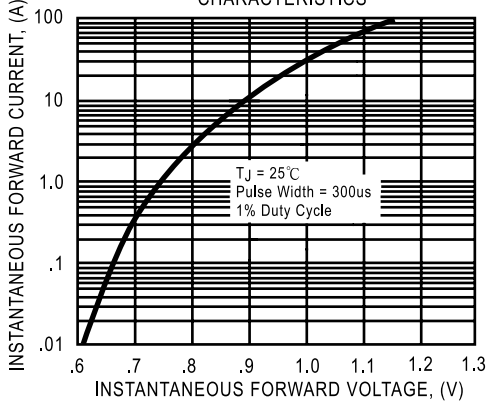
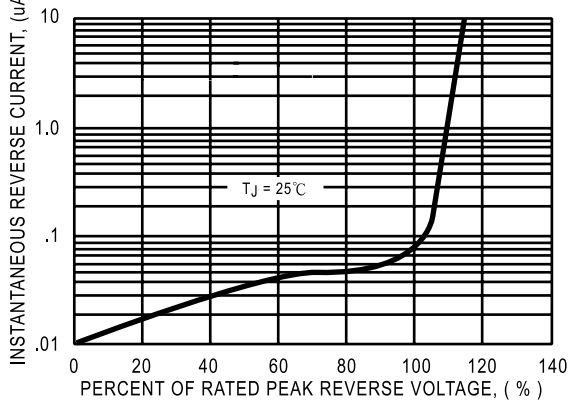

FIG. 4 - TYPICAL REVERSE CHARACTERISTICS





**DC COMPONENTS CO., LTD.**

RECTIFIER SPECIALISTS

KBPC / MB  
25005W / 2505W  
THRU  
KBPC / MB  
2510W / 2510W

**TECHNICAL SPECIFICATIONS OF SINGLE-PHASE SILICON BRIDGE RECTIFIER**

**VOLTAGE RANGE - 50 to 1000 Volts**

**CURRENT - 25 Amperes**

**FEATURES**

- \* Metal case for Maximum Heat Dissipation
- \* Surge overload ratings-400 Amperes
- \* Low forward voltage drop

**MECHANICAL DATA**

- \* Case: Metal, electrically isolated
- \* Epoxy: UL 94V-0 rate flame retardant
- \* Lead: MIL-STD-202E, Method 208 guaranteed
- \* Polarity: As marked
- \* Mounting position: Any
- \* Weight: 30 grams

**MAXIMUM RATINGS AND ELECTRICAL CHARACTERISTICS**

Ratings at 25 °C ambient temperature unless otherwise specified.  
Single phase, half wave, 60 Hz, resistive or inductive load.  
For capacitive load, derate current by 20%.



MB-25W

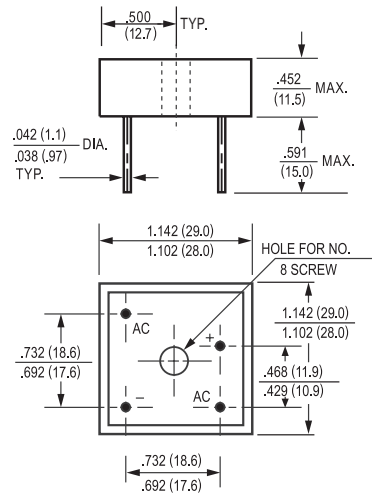

Dimensions in inches and (millimeters)

		KBPC 25005W	KBPC 2501W	KBPC 2502W	KBPC 2504W	KBPC 2506W	KBPC 2508W	KBPC 2510W	
	SYMBOL	MB2505W	MB251W	MB252W	MB254W	MB256W	MB258W	MB2510W	UNITS
Maximum Recurrent Peak Reverse Voltage	V <sub>RRM</sub>	50	100	200	400	600	800	1000	Volts
Maximum RMS Bridge Input Voltage	V <sub>RMS</sub>	35	70	140	280	420	560	700	Volts
Maximum DC Blocking Voltage	V <sub>DC</sub>	50	100	200	400	600	800	1000	Volts
Maximum Average Forward Rectified Output Current at T <sub>c</sub> = 55°C	I <sub>O</sub>	25							Amps
Peak Forward Surge Current 8.3 ms single half sine-wave superimposed on rated load (JEDEC Method)	I <sub>FSM</sub>	400							Amps
Maximum Forward Voltage Drop per element at 12.5A DC	V <sub>F</sub>	1.1							Volts
Maximum DC Reverse Current at Rated	I <sub>R</sub>	@T <sub>A</sub> = 25°C						10	uAmps
DC Blocking Voltage per element		@T <sub>A</sub> = 100°C						500	
I <sup>2</sup> t Rating for Fusing (t<8.3ms)	I <sup>2</sup> t	374							A <sup>2</sup> Sec
Typical Junction Capacitance ( Note1)	C <sub>J</sub>	300							pF
Typical Thermal Resistance ( Note 2)	R <sub>θJC</sub>	2.5							°C/W
Operating and Storage Temperature Range	T <sub>J</sub> , T <sub>STG</sub>	-55 to + 150							°C

NOTES : 1. Measured at 1 MHz and applied reverse voltage of 4.0 volts  
2. Thermal Resistance from Junction to Case per leg.

RATING AND CHARACTERISTIC CURVES ( KBPC25005W MB2505W THRU KBPC2510W MB2510W )

FIG. 1 - MAXIMUM NON-REPETITIVE FORWARD SURGE CURRENT

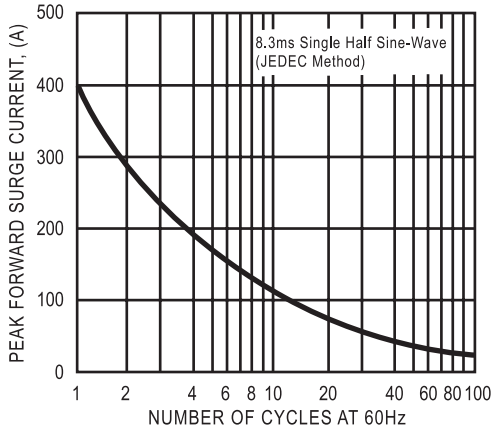

FIG. 2 - TYPICAL FORWARD CURRENT DERATING CURVE

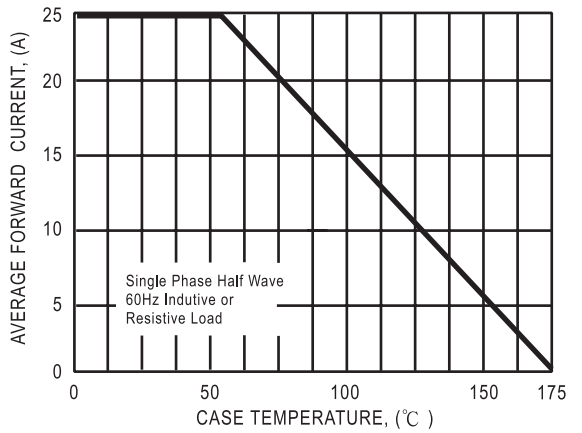

FIG. 3- TYPICAL INSTANTANEOUS FORWARD CHARACTERISTICS

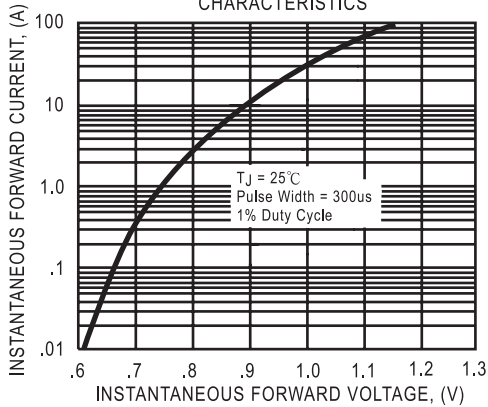

FIG. 4 - TYPICAL REVERSE CHARACTERISTICS

