

IRG4PC50FD

INSULATED GATE BIPOLAR TRANSISTOR WITH
 ULTRAFAST SOFT RECOVERY DIODE

Fast CoPack IGBT

Features

- Fast: Optimized for medium operating frequencies (1-5 kHz in hard switching, >20 kHz in resonant mode).
- Generation 4 IGBT design provides tighter parameter distribution and higher efficiency than Generation 3
- IGBT co-packaged with HEXFRED™ ultrafast, ultra-soft-recovery anti-parallel diodes for use in bridge configurations
- Industry standard TO-247AC package

Benefits

- Generation -4 IGBT's offer highest efficiencies available
- IGBT's optimized for specific application conditions
- HEXFRED diodes optimized for performance with IGBT's . Minimized recovery characteristics require less/no snubbing
- Designed to be a "drop-in" replacement for equivalent industry-standard Generation 3 IR IGBT's

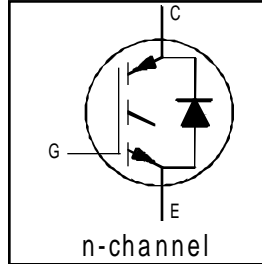

$V_{CES} = 600V$

$V_{CE(on) typ.} = 1.45V$

@ $V_{GE} = 15V, I_C = 39A$

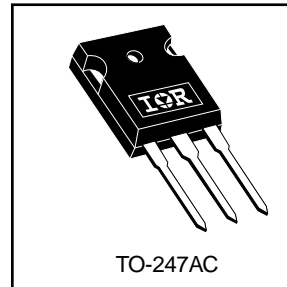

TO-247AC

Absolute Maximum Ratings

	Parameter	Max.	Units
V_{CES}	Collector-to-Emitter Voltage	600	V
$I_C @ T_C = 25^\circ C$	Continuous Collector Current	70	A
$I_C @ T_C = 100^\circ C$	Continuous Collector Current	39	
I_{CM}	Pulsed Collector Current ①	280	
I_{LM}	Clamped Inductive Load Current ②	280	
$I_F @ T_C = 100^\circ C$	Diode Continuous Forward Current	25	
I_{FM}	Diode Maximum Forward Current	280	
V_{GE}	Gate-to-Emitter Voltage	± 20	V
$P_D @ T_C = 25^\circ C$	Maximum Power Dissipation	200	W
$P_D @ T_C = 100^\circ C$	Maximum Power Dissipation	78	
T_J	Operating Junction and Storage Temperature Range	-55 to +150	$^\circ C$
T_{STG}			
	Soldering Temperature, for 10 sec.	300 (0.063 in. (1.6mm) from case)	
	Mounting Torque, 6-32 or M3 Screw.	10 lbf•in (1.1 N•m)	

Thermal Resistance

	Parameter	Min.	Typ.	Max.	Units
$R_{\theta JC}$	Junction-to-Case - IGBT	-----	-----	0.64	$^\circ C/W$
$R_{\theta JC}$	Junction-to-Case - Diode	-----	-----	0.83	
$R_{\theta CS}$	Case-to-Sink, flat, greased surface	-----	0.24	-----	
$R_{\theta JA}$	Junction-to-Ambient, typical socket mount	-----	-----	40	
W_t	Weight	-----	6 (0.21)	-----	g (oz)

Electrical Characteristics @ $T_J = 25^\circ\text{C}$ (unless otherwise specified)

	Parameter	Min.	Typ.	Max.	Units	Conditions
$V_{(BR)CES}$	Collector-to-Emitter Breakdown Voltage ^③	600	----	----	V	$V_{GE} = 0V, I_C = 250\mu A$
$\Delta V_{(BR)CES}/\Delta T_J$	Temperature Coeff. of Breakdown Voltage	----	0.62	----	V/ $^\circ\text{C}$	$V_{GE} = 0V, I_C = 1.0mA$
$V_{CE(on)}$	Collector-to-Emitter Saturation Voltage	----	1.45	1.6	V	$I_C = 39A, V_{GE} = 15V$
		----	1.79	----		$I_C = 70A$
		----	1.53	----		$I_C = 39A, T_J = 150^\circ\text{C}$
$V_{GE(th)}$	Gate Threshold Voltage	3.0	----	6.0		$V_{CE} = V_{GE}, I_C = 250\mu A$
$\Delta V_{GE(th)}/\Delta T_J$	Temperature Coeff. of Threshold Voltage	----	-14	----	mV/ $^\circ\text{C}$	$V_{CE} = V_{GE}, I_C = 250\mu A$
g_{fe}	Forward Transconductance ^④	21	30	----	S	$V_{CE} = 100V, I_C = 39A$
I_{CES}	Zero Gate Voltage Collector Current	----	----	250	μA	$V_{GE} = 0V, V_{CE} = 600V$
		----	----	6500		$V_{GE} = 0V, V_{CE} = 600V, T_J = 150^\circ\text{C}$
V_{FM}	Diode Forward Voltage Drop	----	1.3	1.7	V	$I_C = 25A$
		----	1.2	1.5		$I_C = 25A, T_J = 150^\circ\text{C}$
I_{GES}	Gate-to-Emitter Leakage Current	----	----	± 100	nA	$V_{GE} = \pm 20V$

Switching Characteristics @ $T_J = 25^\circ\text{C}$ (unless otherwise specified)

	Parameter	Min.	Typ.	Max.	Units	Conditions
Q_g	Total Gate Charge (turn-on)	----	190	290	nC	$I_C = 39A$
Q_{ge}	Gate - Emitter Charge (turn-on)	----	28	42		$V_{CC} = 400V$
Q_{gc}	Gate - Collector Charge (turn-on)	----	65	97		$V_{GE} = 15V$
$t_{d(on)}$	Turn-On Delay Time	----	55	----	ns	$T_J = 25^\circ\text{C}$
t_r	Rise Time	----	25	----		$I_C = 39A, V_{CC} = 480V$
$t_{d(off)}$	Turn-Off Delay Time	----	240	360	ns	$V_{GE} = 15V, R_G = 5.0\Omega$
t_f	Fall Time	----	140	210		Energy losses include "tail" and diode reverse recovery.
E_{on}	Turn-On Switching Loss	----	1.5	----	mJ	See Fig. 9, 10, 11, 18
E_{off}	Turn-Off Switching Loss	----	2.4	----		
E_{ts}	Total Switching Loss	----	3.9	5.0		
$t_{d(on)}$	Turn-On Delay Time	----	59	----	ns	$T_J = 150^\circ\text{C}$, See Fig. 9, 10, 11, 18
t_r	Rise Time	----	27	----		$I_C = 39A, V_{CC} = 480V$
$t_{d(off)}$	Turn-Off Delay Time	----	400	----	ns	$V_{GE} = 15V, R_G = 5.0\Omega$
t_f	Fall Time	----	260	----		Energy losses include "tail" and diode reverse recovery.
E_{ts}	Total Switching Loss	----	6.5	----	mJ	
L_E	Internal Emitter Inductance	----	13	----	nH	Measured 5mm from package
C_{ies}	Input Capacitance	----	4100	----	pF	$V_{GE} = 0V$
C_{oes}	Output Capacitance	----	250	----		$V_{CC} = 30V$
C_{res}	Reverse Transfer Capacitance	----	49	----		$f = 1.0MHz$
t_{rr}	Diode Reverse Recovery Time	----	50	75	ns	$T_J = 25^\circ\text{C}$ See Fig. 14
		----	105	160		$T_J = 125^\circ\text{C}$
I_{rr}	Diode Peak Reverse Recovery Current	----	4.5	10	A	$T_J = 25^\circ\text{C}$ See Fig. 15
		----	8.0	15		$T_J = 125^\circ\text{C}$
Q_{rr}	Diode Reverse Recovery Charge	----	112	375	nC	$T_J = 25^\circ\text{C}$ See Fig. 16
		----	420	1200		$T_J = 125^\circ\text{C}$
$di_{(rec)M}/dt$	Diode Peak Rate of Fall of Recovery During t_b	----	250	----	A/ μs	$T_J = 25^\circ\text{C}$ See Fig. 17
		----	160	----		$T_J = 125^\circ\text{C}$

$I_F = 25A$
 $V_R = 200V$
 $di/dt 200A/\mu s$

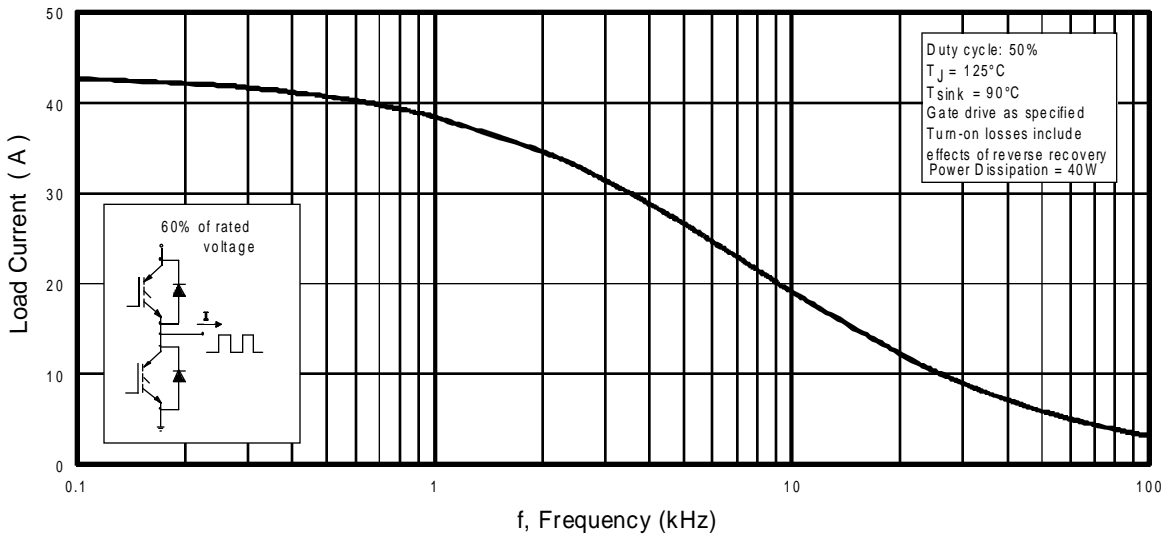

Fig. 1 - Typical Load Current vs. Frequency
 (Load Current = I_{RMS} of fundamental)

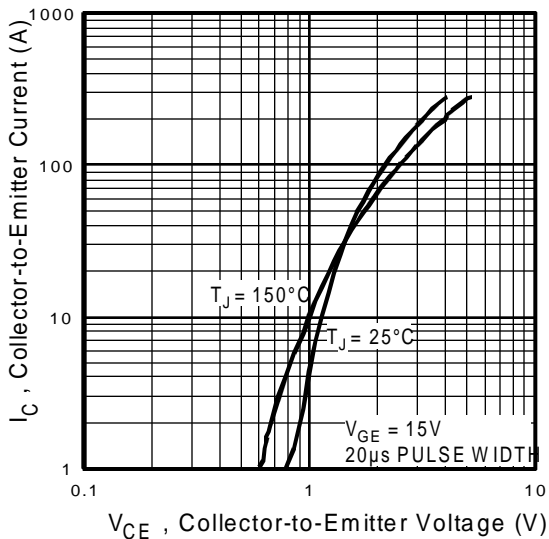

Fig. 2 - Typical Output Characteristics

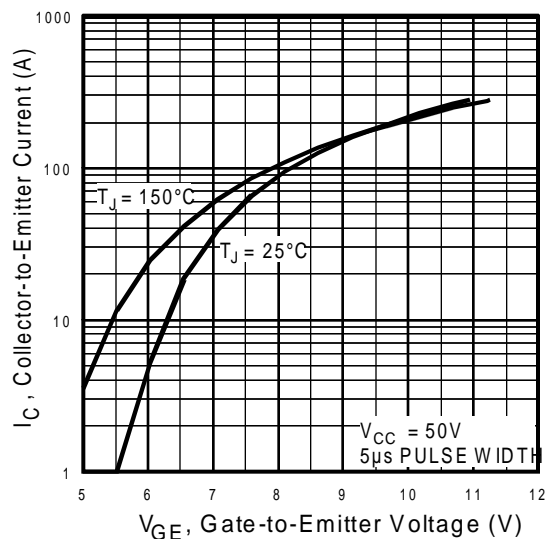

Fig. 3 - Typical Transfer Characteristics

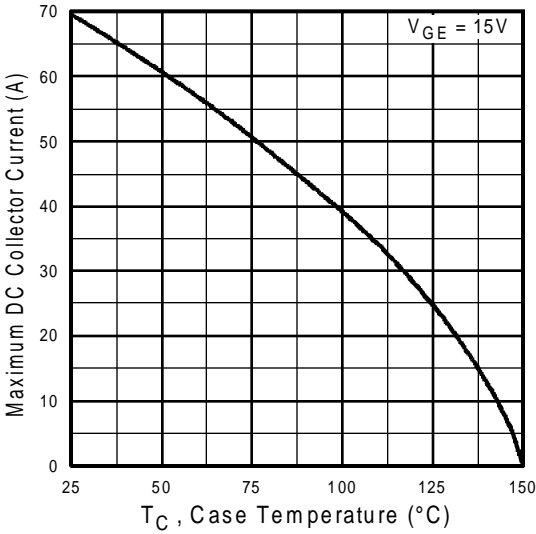

Fig. 4 - Maximum Collector Current vs. Case Temperature

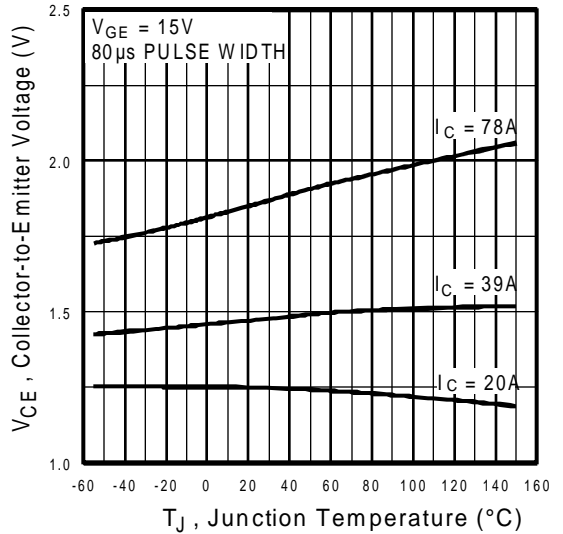

Fig. 5 - Typical Collector-to-Emitter Voltage vs. Junction Temperature

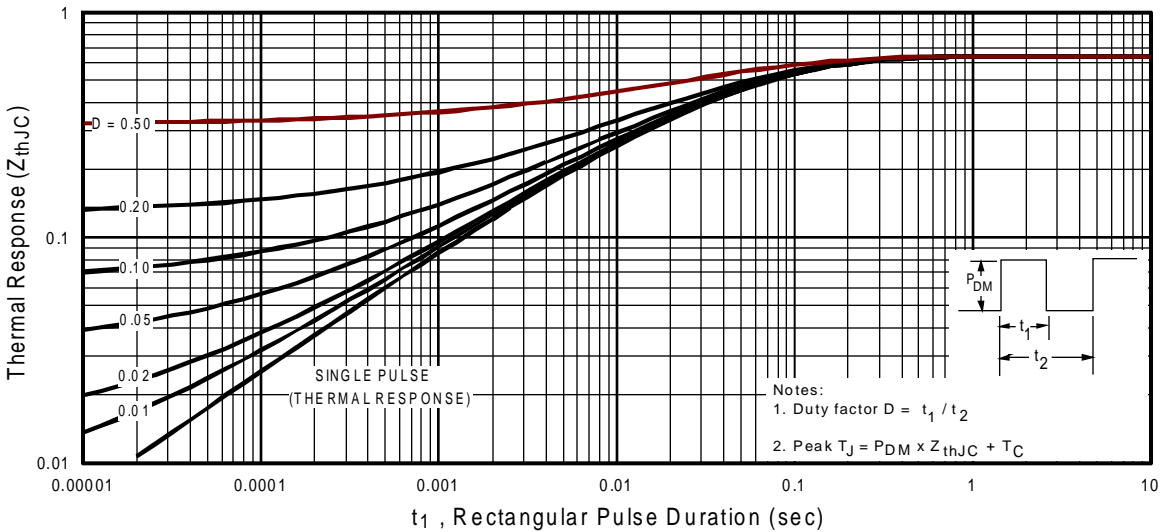

Fig. 6 - Maximum IGBT Effective Transient Thermal Impedance, Junction-to-Case

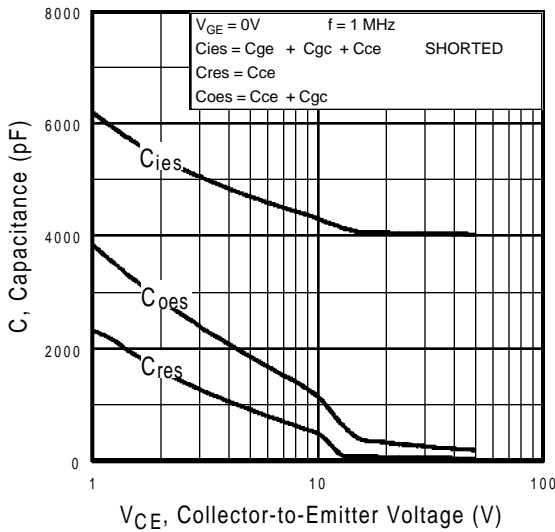

Fig. 7 - Typical Capacitance vs. Collector-to-Emitter Voltage

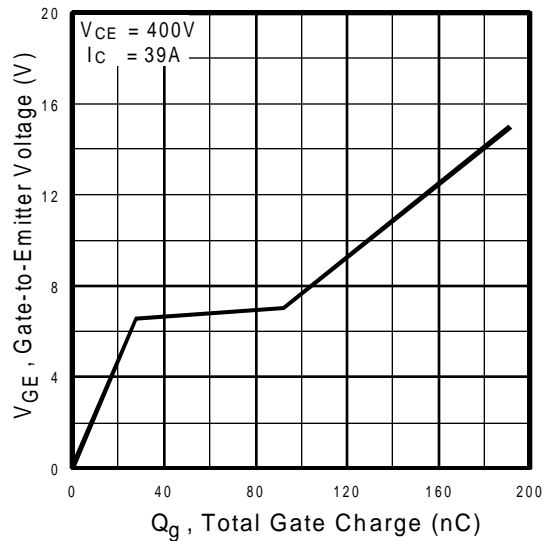

Fig. 8 - Typical Gate Charge vs. Gate-to-Emitter Voltage

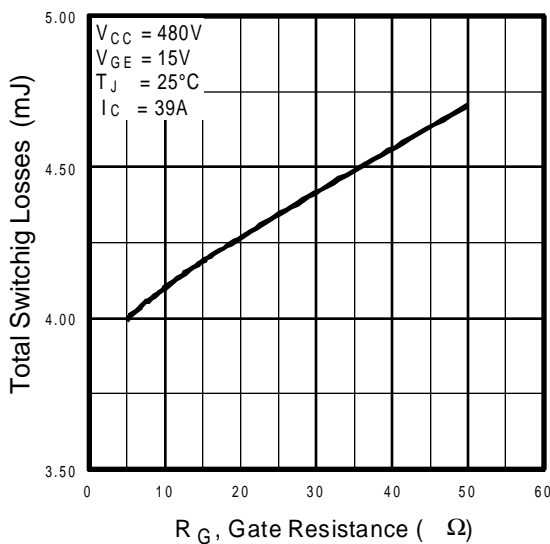

Fig. 9 - Typical Switching Losses vs. Gate Resistance

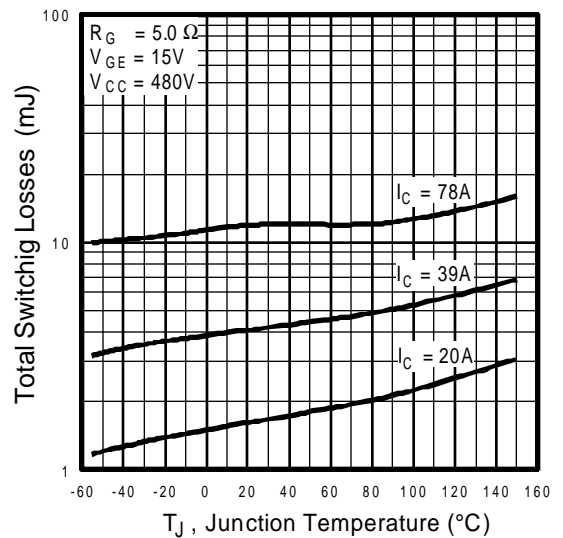

Fig. 10 - Typical Switching Losses vs. Junction Temperature

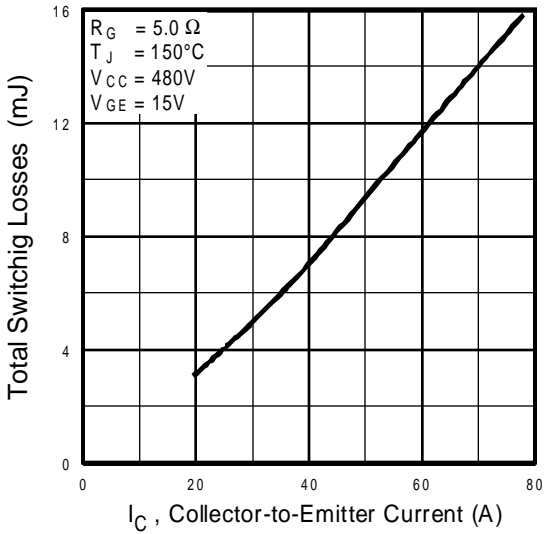

Fig. 11 - Typical Switching Losses vs. Collector-to-Emitter Current

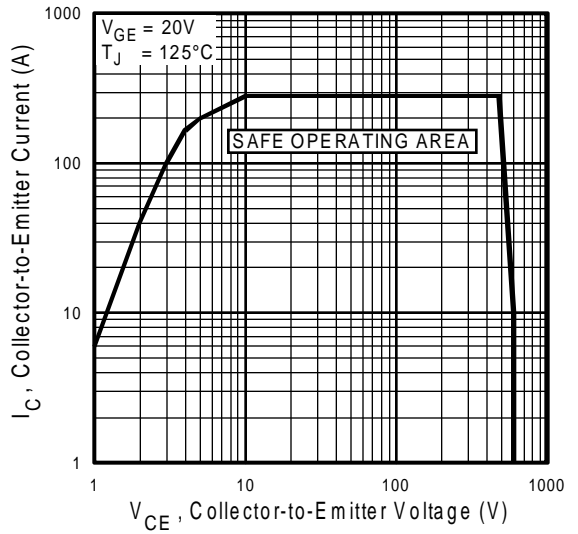

Fig. 12 - Turn-Off SOA

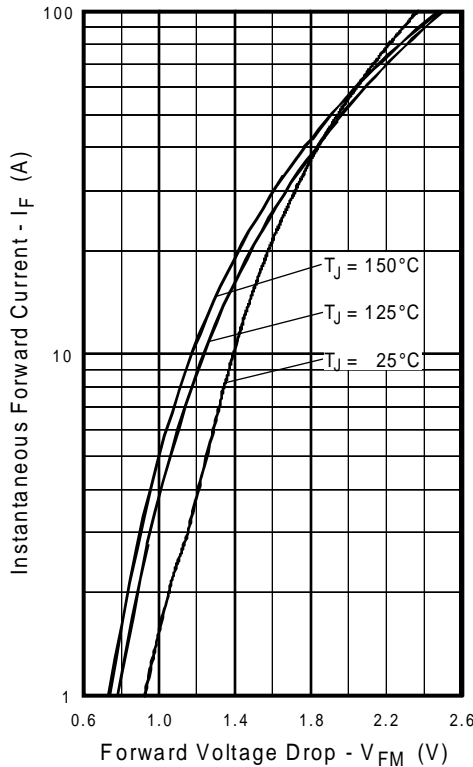

Fig. 13 - Maximum Forward Voltage Drop vs. Instantaneous Forward Current

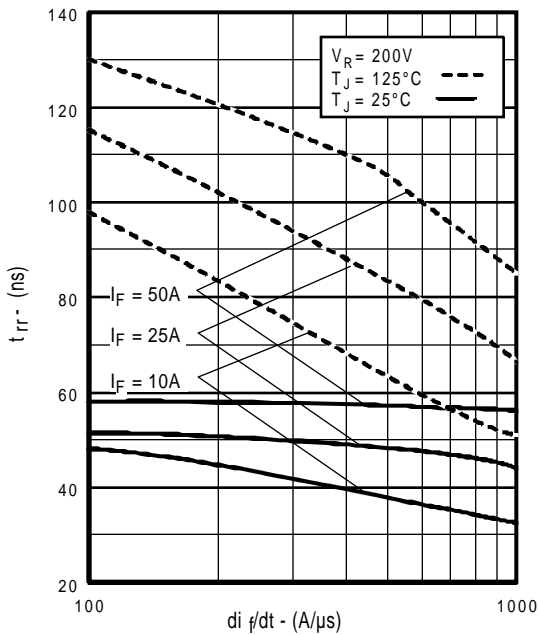

Fig. 14 - Typical Reverse Recovery vs. di_f/dt

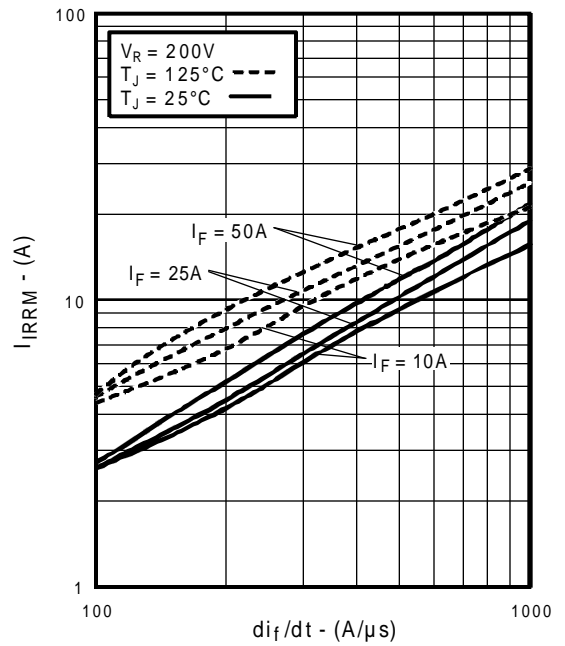

Fig. 15 - Typical Recovery Current vs. di_f/dt

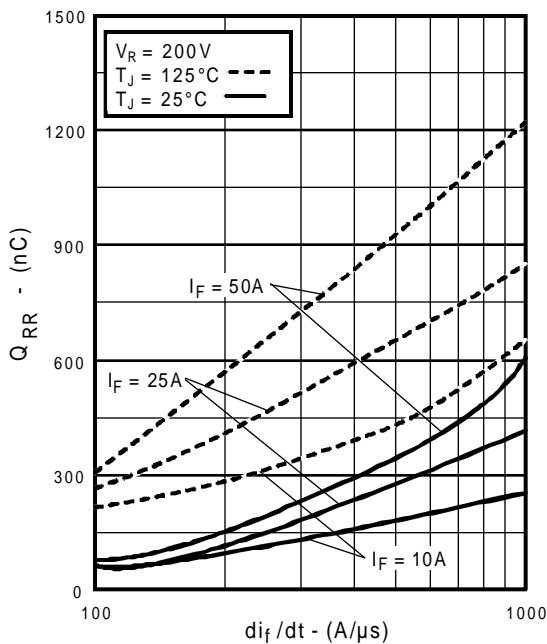

Fig. 16 - Typical Stored Charge vs. di_f/dt

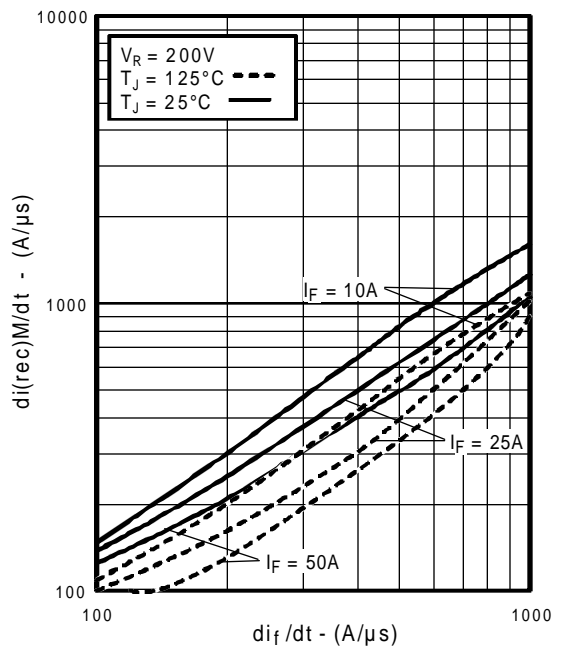

Fig. 17 - Typical $di_{(rec)M}/dt$ vs. di_f/dt

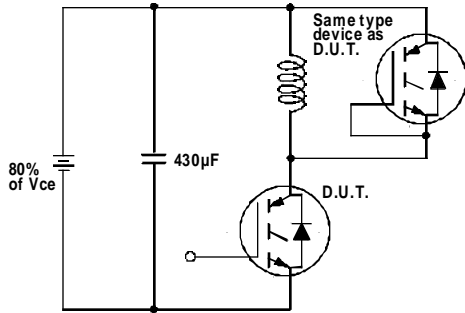

Fig. 18a - Test Circuit for Measurement of I_{LM} , E_{on} , $E_{off}(\text{diode})$, t_{rr} , Q_{rr} , I_{rr} , $t_{d(on)}$, t_r , $t_{d(off)}$, t_f

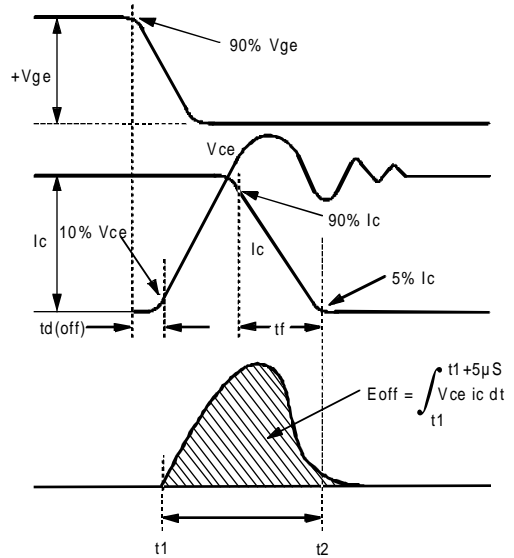

Fig. 18b - Test Waveforms for Circuit of Fig. 18a, Defining E_{off} , $t_{d(off)}$, t_f

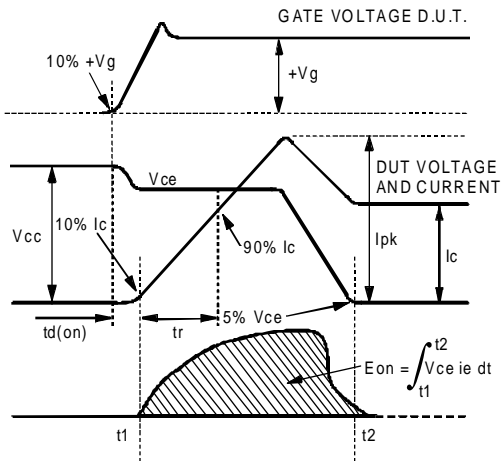

Fig. 18c - Test Waveforms for Circuit of Fig. 18a, Defining E_{on} , $t_{d(on)}$, t_r

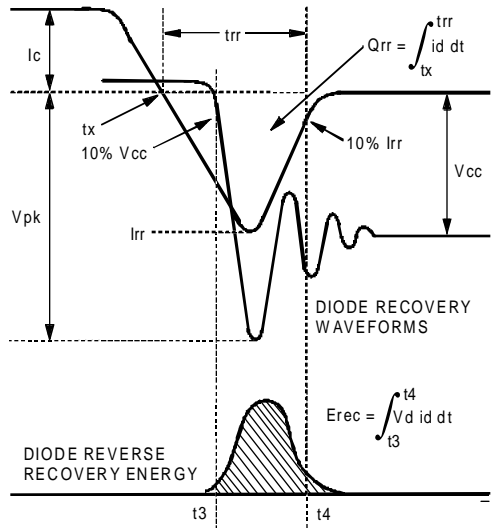

Fig. 18d - Test Waveforms for Circuit of Fig. 18a, Defining E_{rec} , t_{tr} , Q_{rr} , I_{rr}

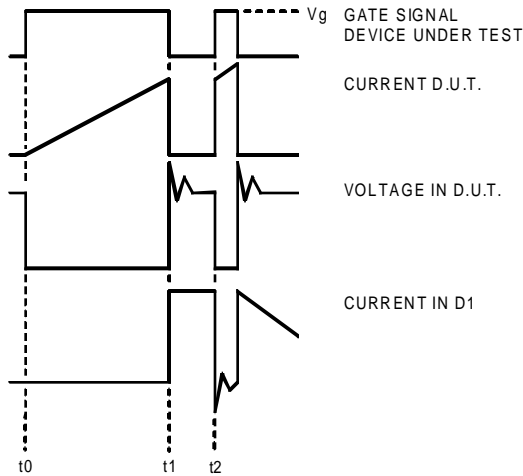

Figure 18e. Macro Waveforms for Figure 18a's Test Circuit

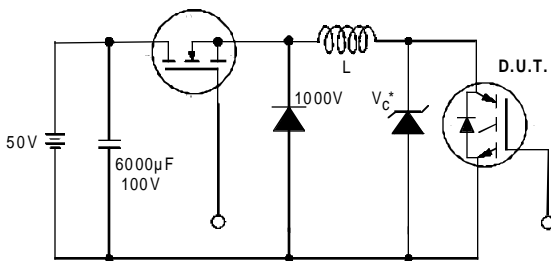

Figure 19. Clamped Inductive Load Test Circuit

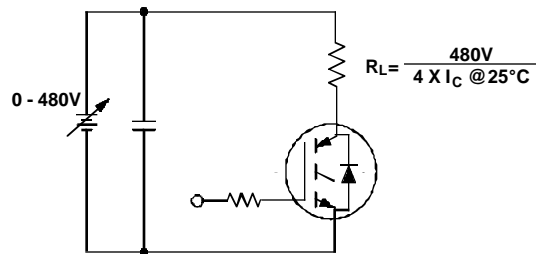

Figure 20. Pulsed Collector Current Test Circuit

Notes:

- ① Repetitive rating: $V_{GE}=20V$; pulse width limited by maximum junction temperature (figure 20)
- ② $V_{CC}=80\%(V_{CES})$, $V_{GE}=20V$, $L=10\mu H$, $R_G = 5.0\Omega$ (figure 19)
- ③ Pulse width $\leq 80\mu s$; duty factor $\leq 0.1\%$.
- ④ Pulse width $5.0\mu s$, single shot.

Case Outline — TO-247AC

