

IRG4PC50KD

INSULATED GATE BIPOLAR TRANSISTOR WITH
ULTRAFAST SOFT RECOVERY DIODE

Short Circuit Rated
UltraFast IGBT

Features

- Short Circuit Rated UltraFast: Optimized for high operating frequencies >5.0 kHz, and Short Circuit Rated to 10 μ s @ 125°C, $V_{GE} = 15V$
- Generation 4 IGBT design provides tighter parameter distribution and higher efficiency than Generation 3
- IGBT co-packaged with HEXFRED™ ultrafast, ultra-soft recovery anti-parallel diodes for use in bridge configurations
- Industry standard TO-247AC package

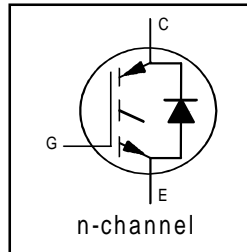

$V_{CES} = 600V$
$V_{CE(on) typ.} = 1.84V$
@ $V_{GE} = 15V, I_C = 30A$

Benefits

- Generation 4 IGBTs offer highest efficiencies available
- HEXFRED diodes optimized for performance with IGBTs. Minimized recovery characteristics require less/no snubbing
- Designed to be a "drop-in" replacement for equivalent industry-standard Generation 3 IR IGBTs

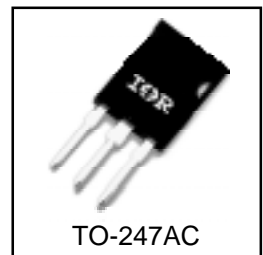

Absolute Maximum Ratings

	Parameter	Max.	Units
V_{CES}	Collector-to-Emitter Voltage	600	V
$I_C @ T_C = 25^\circ C$	Continuous Collector Current	52	A
$I_C @ T_C = 100^\circ C$	Continuous Collector Current	30	
I_{CM}	Pulsed Collector Current ①	104	
I_{LM}	Clamped Inductive Load Current ②	104	
$I_F @ T_C = 100^\circ C$	Diode Continuous Forward Current	25	
I_{FM}	Diode Maximum Forward Current	280	
t_{sc}	Short Circuit Withstand Time	10	μ s
V_{GE}	Gate-to-Emitter Voltage	± 20	V
$P_D @ T_C = 25^\circ C$	Maximum Power Dissipation	200	W
$P_D @ T_C = 100^\circ C$	Maximum Power Dissipation	78	
T_J	Operating Junction and	-55 to +150	$^\circ C$
T_{STG}	Storage Temperature Range		
	Soldering Temperature, for 10 sec.	300 (0.063 in. (1.6mm) from case)	
	Mounting Torque, 6-32 or M3 Screw.	10 lbf•in (1.1 N•m)	

Thermal Resistance

	Parameter	Min.	Typ.	Max.	Units
$R_{\theta JC}$	Junction-to-Case - IGBT	—	—	0.64	$^\circ C/W$
$R_{\theta JC}$	Junction-to-Case - Diode	—	—	0.83	
$R_{\theta CS}$	Case-to-Sink, flat, greased surface	—	0.24	—	
$R_{\theta JA}$	Junction-to-Ambient, typical socket mount	—	—	40	
Wt	Weight	—	6 (0.21)	—	g (oz)

Electrical Characteristics @ T_J = 25°C (unless otherwise specified)

	Parameter	Min.	Typ.	Max.	Units	Conditions
V _{(BR)CES}	Collector-to-Emitter Breakdown Voltage ③	600	—	—	V	V _{GE} = 0V, I _C = 250μA
DV _{(BR)CES} /DT _J	Temperature Coeff. of Breakdown Voltage	—	0.47	—	V/°C	V _{GE} = 0V, I _C = 1.0mA
V _{CE(on)}	Collector-to-Emitter Saturation Voltage	—	1.84	2.2	V	I _C = 30A V _{GE} = 15V
		—	2.19	—		I _C = 52A see figures 2, 5
		—	1.79	—		I _C = 25A, T _J = 150°C
V _{GE(th)}	Gate Threshold Voltage	3.0	—	6.0		V _{CE} = V _{GE} , I _C = 250μA
DV _{GE(th)} /DT _J	Temperature Coeff. of Threshold Voltage	—	-12	—	mV/°C	V _{CE} = V _{GE} , I _C = 250μA
g _{fe}	Forward Transconductance ④	17	24	—	S	V _{CE} = 100V, I _C = 30A
I _{CES}	Zero Gate Voltage Collector Current	—	—	250	μA	V _{GE} = 0V, V _{CE} = 600V
		—	—	6500		V _{GE} = 0V, V _{CE} = 600V, T _J = 150°C
V _{FM}	Diode Forward Voltage Drop	—	1.3	1.7	V	I _C = 25A see figure 13
		—	1.2	1.5		I _C = 25A, T _J = 150°C
I _{GES}	Gate-to-Emitter Leakage Current	—	—	±100	nA	V _{GE} = ±20V

Switching Characteristics @ T_J = 25°C (unless otherwise specified)

	Parameter	Min.	Typ.	Max.	Units	Conditions	
Q _g	Total Gate Charge (turn-on)	—	200	300	nC	I _C = 30A	
Q _{ge}	Gate - Emitter Charge (turn-on)	—	25	38		V _{CC} = 400V see figure 8	
Q _{gc}	Gate - Collector Charge (turn-on)	—	85	127		V _{GE} = 15V	
t _{d(on)}	Turn-On Delay Time	—	63	—	ns	T _J = 25°C I _C = 30A, V _{CC} = 480V V _{GE} = 15V, R _G = 5.0Ω	
t _r	Rise Time	—	49	—			
t _{d(off)}	Turn-Off Delay Time	—	150	220			
t _f	Fall Time	—	95	140			
E _{on}	Turn-On Switching Loss	—	1.61	—			mJ
E _{off}	Turn-Off Switching Loss	—	0.84	—			
E _{ts}	Total Switching Loss	—	2.45	3.0	see figures 9,10,18		
t _{sc}	Short Circuit Withstand Time	10	—	—	μs	V _{CC} = 360V, T _J = 125°C V _{GE} = 15V, R _G = 10Ω, V _{CPK} < 500V	
t _{d(on)}	Turn-On Delay Time	—	61	—	ns	T _J = 150°C, see figures 11,18 I _C = 30A, V _{CC} = 480V V _{GE} = 15V, R _G = 5.0Ω Energy losses include "tail" and diode reverse recovery	
t _r	Rise Time	—	46	—			
t _{d(off)}	Turn-Off Delay Time	—	310	—			
t _f	Fall Time	—	170	—			
E _{ts}	Total Switching Loss	—	3.53	—			mJ
L _E	Internal Emitter Inductance	—	13	—	nH	Measured 5mm from package	
C _{ies}	Input Capacitance	—	3200	—	pF	V _{GE} = 0V V _{CC} = 30V see figure 7 f = 1.0MHz	
C _{oes}	Output Capacitance	—	370	—			
C _{res}	Reverse Transfer Capacitance	—	95	—			
t _{rr}	Diode Reverse Recovery Time	—	50	75	ns	T _J = 25°C see figure	I _F = 25A V _R = 200V di/dt 200A/μs
		—	105	160		T _J = 125°C 14	
I _{rr}	Diode Peak Reverse Recovery Current	—	4.5	10	A	T _J = 25°C see figure	
		—	8.0	15		T _J = 125°C 15	
Q _{rr}	Diode Reverse Recovery Charge	—	112	375	nC	T _J = 25°C see figure	
		—	420	1200		T _J = 125°C 16	
di _(rec) M/dt	Diode Peak Rate of Fall of Recovery During t _b	—	250	—	A/μs	T _J = 25°C see figure	
		—	160	—		T _J = 125°C 17	

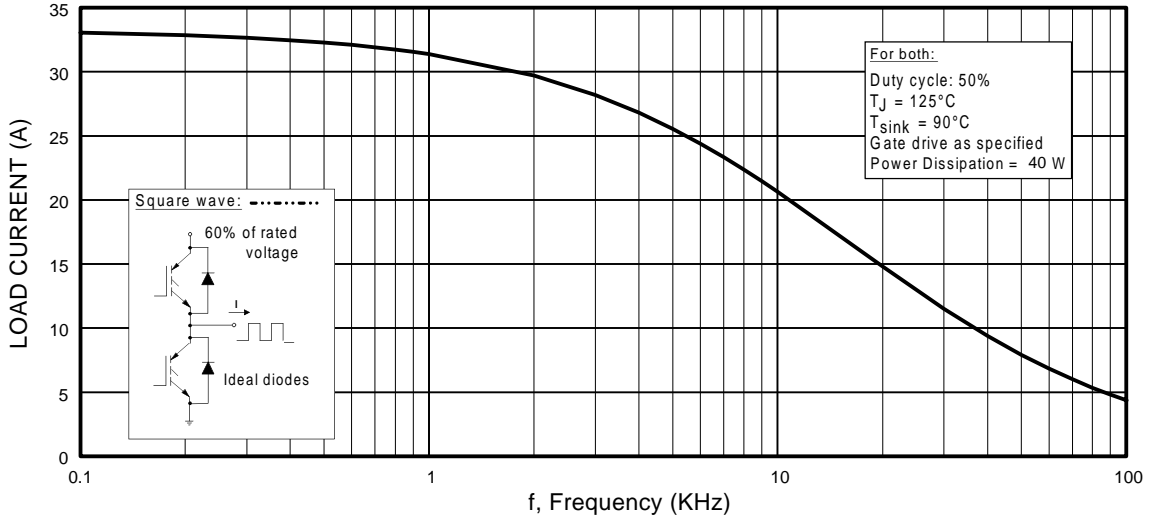

Fig. 1 - Typical Load Current vs. Frequency
 (Load Current = I_{RMS} of fundamental)

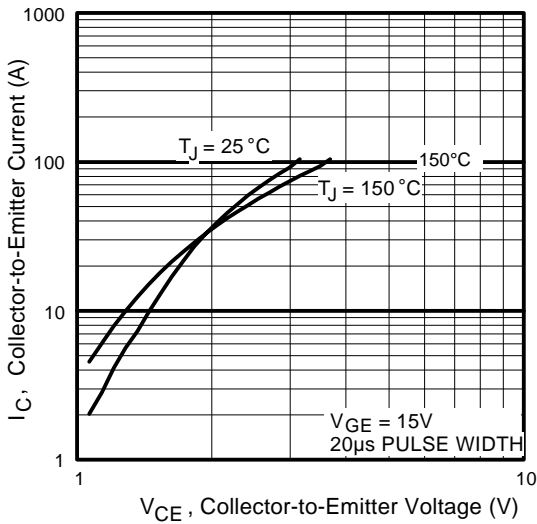

Fig. 2 - Typical Output Characteristics

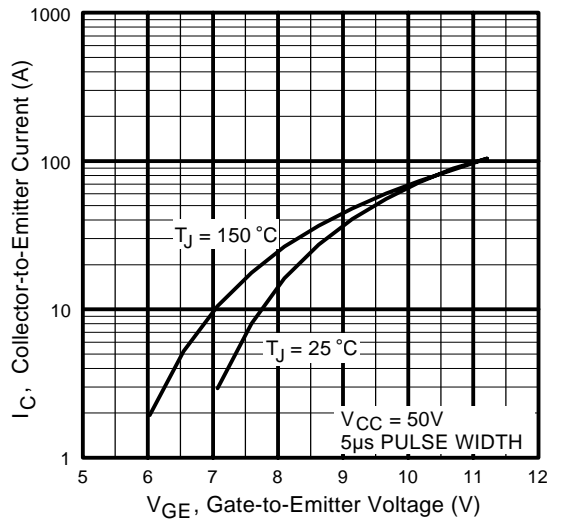

Fig. 3 - Typical Transfer Characteristics

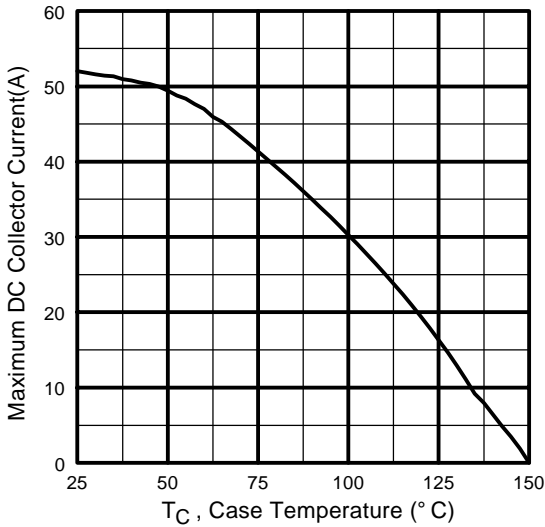

Fig. 4 - Maximum Collector Current vs. Case Temperature

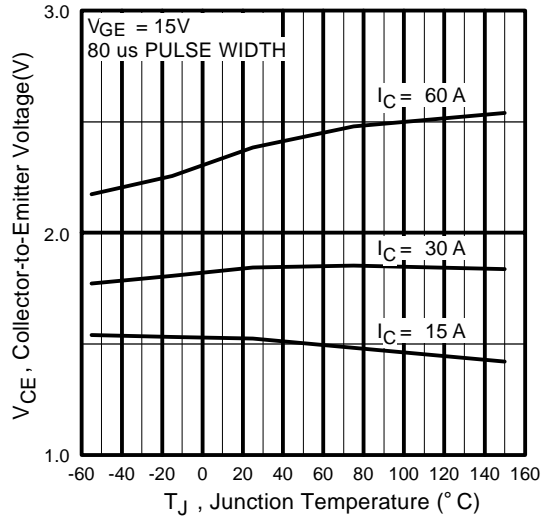

Fig. 5 - Typical Collector-to-Emitter Voltage vs. Junction Temperature

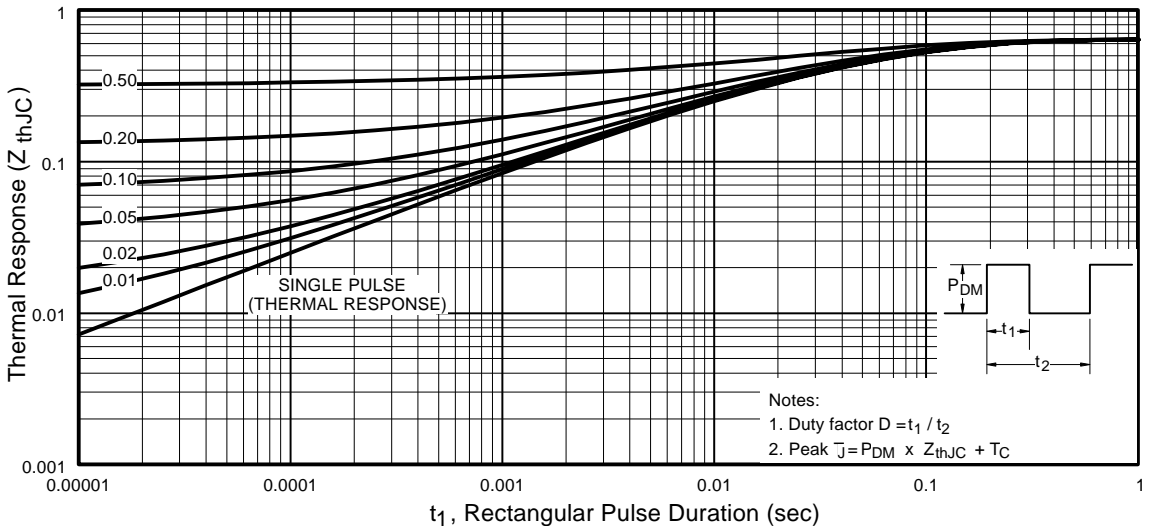

Fig. 6 - Maximum Effective Transient Thermal Impedance, Junction-to-Case

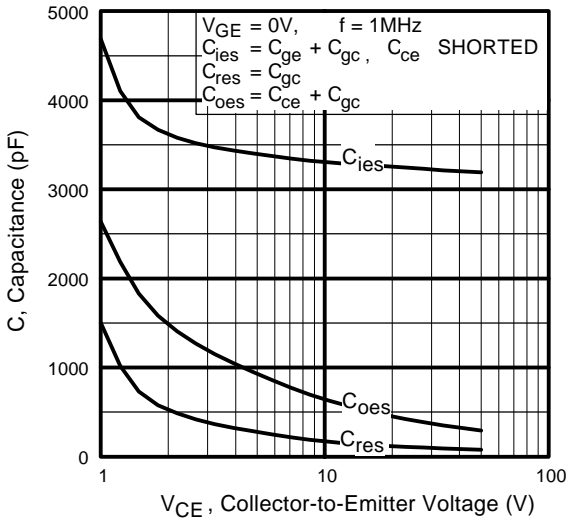

Fig. 7 - Typical Capacitance vs. Collector-to-Emitter Voltage

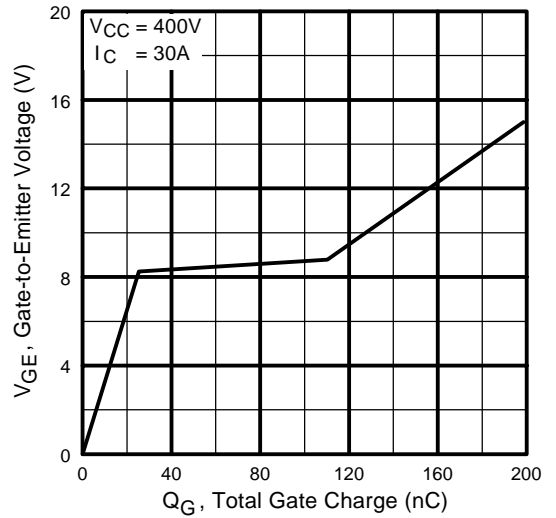

Fig. 8 - Typical Gate Charge vs. Gate-to-Emitter Voltage

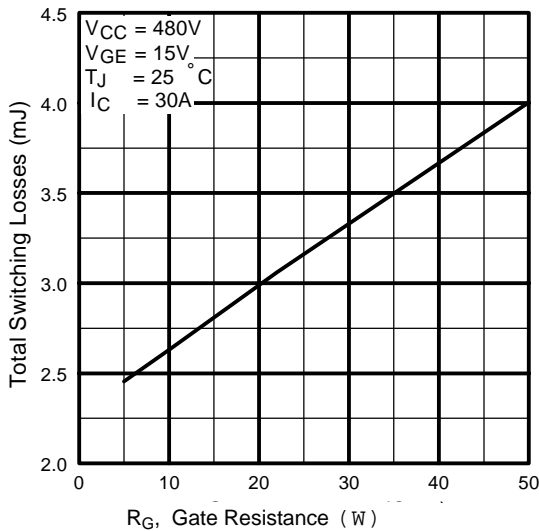

Fig. 9 - Typical Switching Losses vs. Gate Resistance

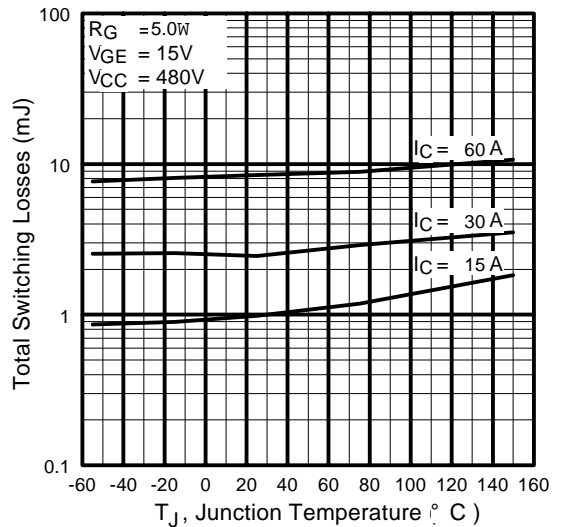

Fig. 10 - Typical Switching Losses vs. Junction Temperature

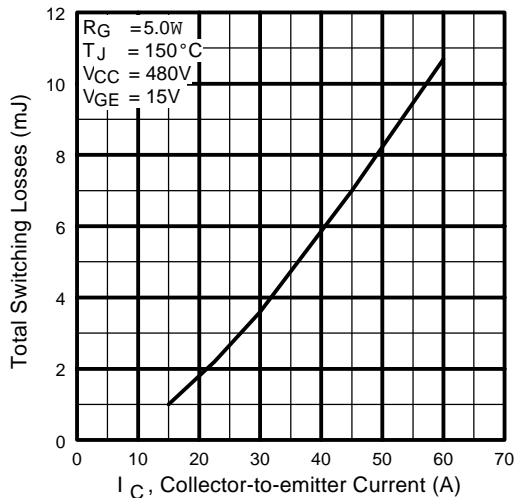

Fig. 11 - Typical Switching Losses vs. Collector-to-Emitter Current

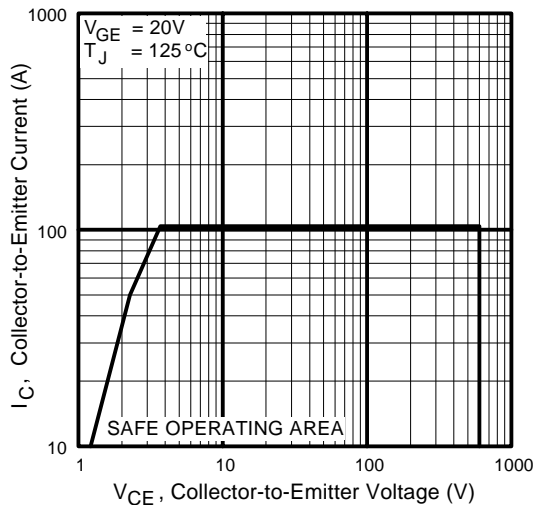

Fig. 12 - Turn-Off SOA

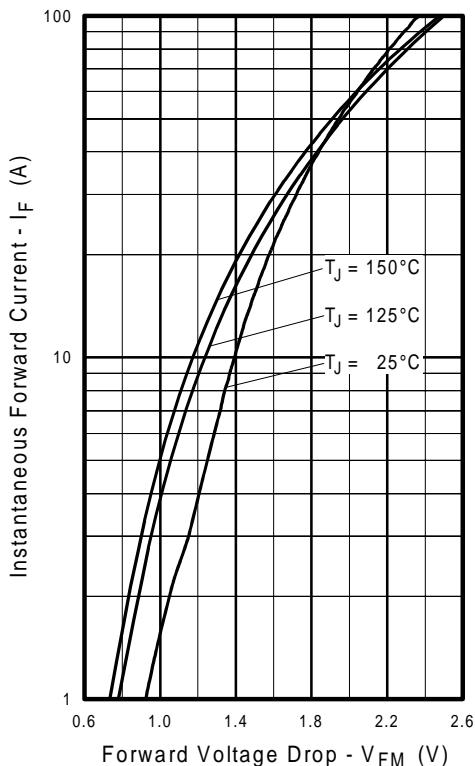

Fig. 13 - Maximum Forward Voltage Drop vs. Instantaneous Forward Current

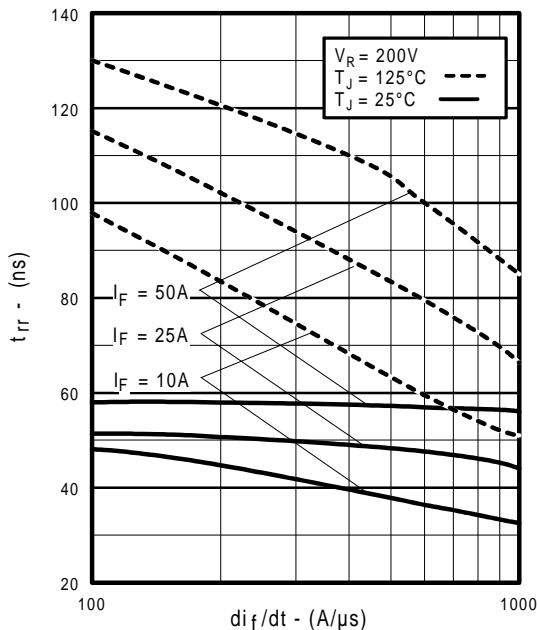

Fig. 14 - Typical Reverse Recovery vs. di_f/dt

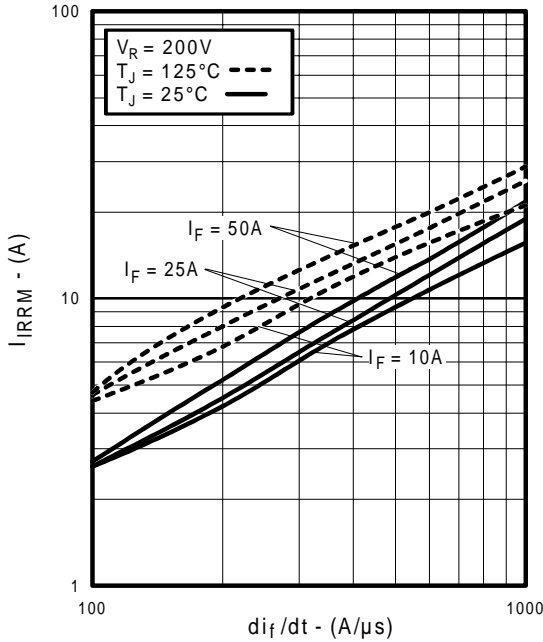

Fig. 15 - Typical Recovery Current vs. di_f/dt

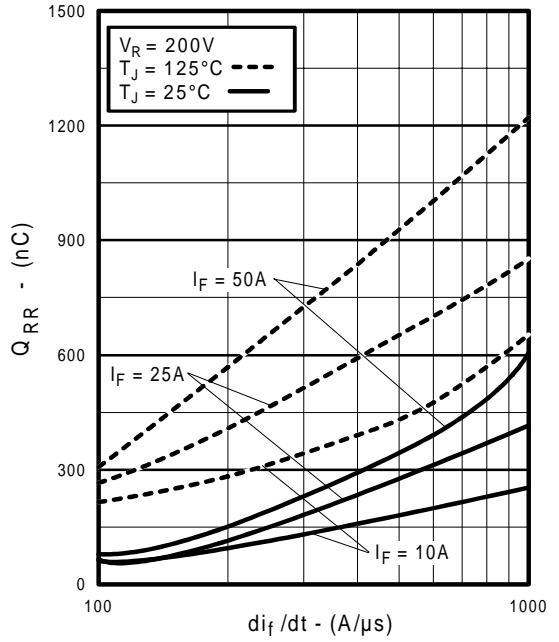

Fig. 16 - Typical Stored Charge vs. di_f/dt

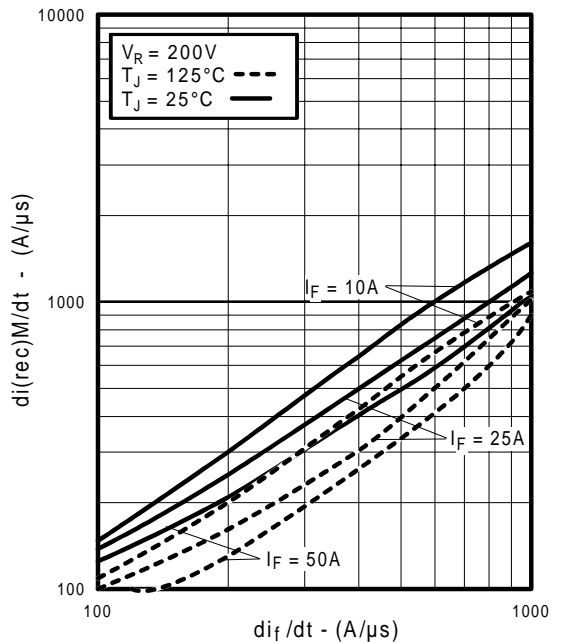

Fig. 17 - Typical $di_{(rec)M}/dt$ vs. di_f/dt

Mechanical drawings, Appendix A
 Test Circuit diagrams, Appendix B
 Switching Loss Waveforms, Appendix C

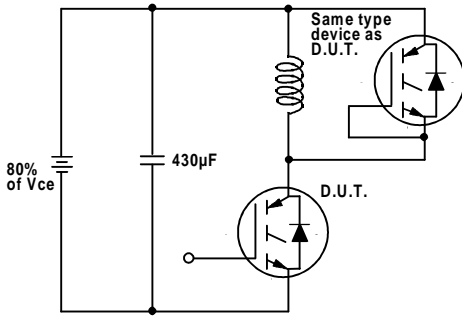

Fig. 18a - Test Circuit for Measurement of I_{LM} , E_{on} , $E_{off(diode)}$, t_{rr} , Q_{rr} , I_{rr} , $t_{d(on)}$, t_r , $t_{d(off)}$, t_f

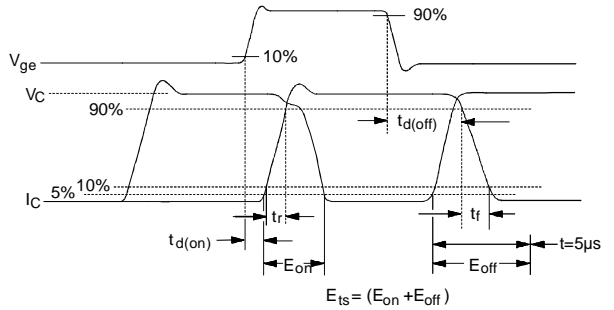

Fig. 18b - Test Waveforms for Circuit of Fig. 18a, Defining E_{off} , $t_{d(off)}$, t_f

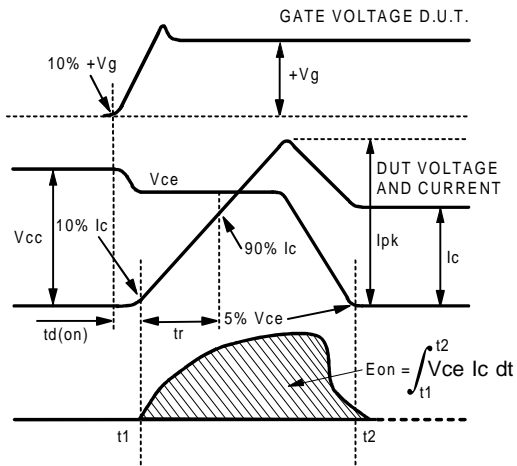

Fig. 18c - Test Waveforms for Circuit of Fig. 18a, Defining E_{on} , $t_{d(on)}$, t_r

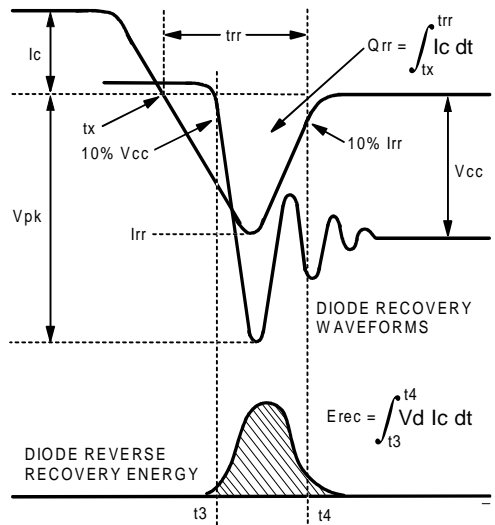

Fig. 18d - Test Waveforms for Circuit of Fig. 18a, Defining E_{rec} , t_{rr} , Q_{rr} , I_{rr}

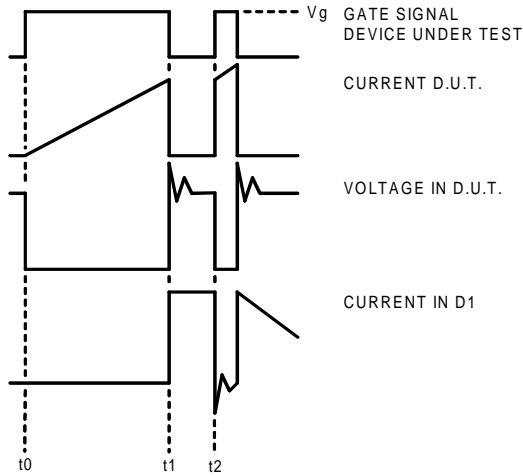

Figure 18e. Macro Waveforms for Figure 18a's Test Circuit

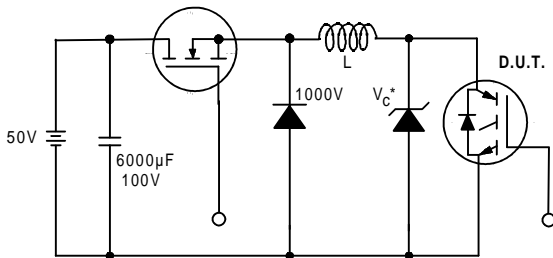

Figure 19. Clamped Inductive Load Test Circuit

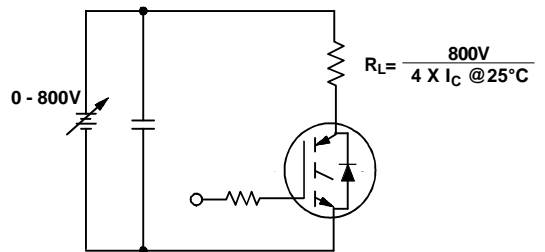
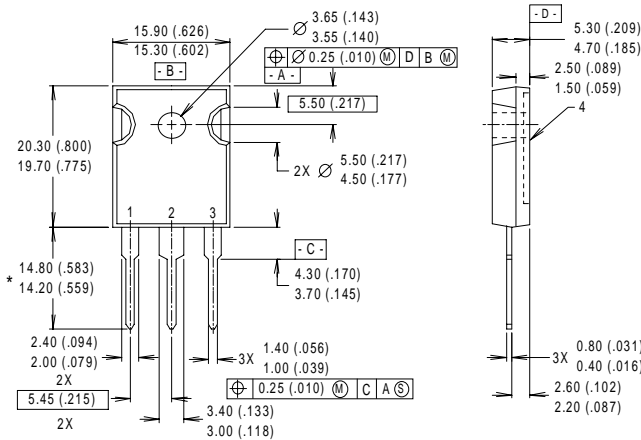

Figure 20. Pulsed Collector Current Test Circuit

Notes:

- ① Repetitive rating: $V_{GE}=20V$; pulse width limited by maximum junction temperature (figure 20)
- ② $V_{CC}=80\% (V_{CES})$, $V_{GE}=20V$, $I=10\mu H$, $R_G=5.0W$ (figure 19)
- ③ Pulse width $\leq 80\mu s$; duty factor $\leq 0.1\%$.
- ④ Pulse width $5.0\mu s$, single shot.

Case Outline — TO-247AC



- NOTES:
- 1 DIMENSIONS & TOLERANCING PER ANSI Y14.5M, 1982.
 - 2 CONTROLLING DIMENSION : INCH.
 - 3 DIMENSIONS ARE SHOWN MILLIMETERS (INCHES).
 - 4 CONFORMS TO JEDEC OUTLINE TO-247AC.

- LEAD ASSIGNMENTS
- 1 - GATE
 - 2 - COLLECTOR
 - 3 - EMITTER
 - 4 - COLLECTOR

* LONGER LEADED (20mm) VERSION AVAILABLE (TO-247AD) TO ORDER ADD "E" SUFFIX TO PART NUMBER

CONFORMS TO JEDEC OUTLINE TO-247AC (TO-3P)
Dimensions in Millimeters and (Inches)

WORLD HEADQUARTERS: 233 Kansas St., El Segundo, California 90245, Tel: (310) 322 3331

IR GREAT BRITAIN: Hurst Green, Oxted, Surrey RH8 9BB, UK Tel: ++ 44 1883 732020

IR CANADA: 15 Lincoln Court, Brampton, Ontario L6T3Z2, Tel: (905) 453 2200

IR GERMANY: Saalburgstrasse 157, 61350 Bad Homburg Tel: ++ 49 6172 96590

IR ITALY: Via Liguria 49, 10071 Borgaro, Torino Tel: ++ 39 11 451 0111

IR FAR EAST: K&H Bldg., 2F, 30-4 Nishi-Ikebukuro 3-Chome, Toshima-Ku, Tokyo Japan 171 Tel: 81 3 3983 0086

IR SOUTHEAST ASIA: 1 Kim Seng Promenade, Great World City West Tower, 13-11, Singapore 237994 Tel: ++ 65 838 4630

IR TAIWAN: 16 Fl. Suite D. 207, Sec. 2, Tun Haw South Road, Taipei, 10673, Taiwan Tel: 886-2-2377-9936

<http://www.irf.com/> Data and specifications subject to change without notice. 12/98